

JAGUAR F-TYPE 2018



THE ART OF PERFORMANCE





BY APPOINTMENT TO
HM THE QUEEN
MANUFACTURERS OF
MOTOR VEHICLES
JAGUAR LAND ROVER LIMITED
COVENTRY



BY APPOINTMENT TO
HRH THE DUKE OF EDINBURGH
MANUFACTURERS OF
MOTOR VEHICLES
JAGUAR LAND ROVER LIMITED
COVENTRY



BY APPOINTMENT TO
HRH THE PRINCE OF WALES
MANUFACTURERS OF
MOTOR VEHICLES
JAGUAR LAND ROVER LIMITED
COVENTRY



JAGUAR

THE ART OF PERFORMANCE

Every day we push performance to its limit. Our performance. Our vehicles' performance.
We innovate, we engineer, we design. We master rules and then break them.
Only to push further. Past the limits of convention. This is when performance becomes art.

Jaguar. The Art of Performance.



CONTENTS

INTRODUCTION

The Concept of F-TYPE	06
F-TYPE - The Facts	08

DESIGN

Exterior Principles	10
Exterior Detail	12
LED Headlights	14
Interior Connection	16
An Exclusive Space	18
Lightweight Seats	20
Luggage Space	22

PERFORMANCE

Engines Overview	24
i4 Engine	25
V6 Engines	26
V8 Engines	28
Lightweight Aluminum Architecture	30
Chassis and Suspension	32
Advanced Aerodynamics	34
Tested To The Extreme	36

DRIVING TECHNOLOGY

Advanced Driving Dynamics	38
Dynamic Mode and Configurable Dynamics	40
Advanced Drivetrain Technology	42
Torque Vectoring	44
Stability and Control	46
Performance Braking Systems	48

INCONTROL® TECHNOLOGIES

Infotainment and Connectivity	50
Touch Pro™ and Connect Pro	52
Audio	54

ADVANCED DRIVER ASSISTANCE

56

F-TYPE 400 SPORT SPECIAL EDITION

58

F-TYPE SVR

Special Vehicle Operations	60
The Concept of F-TYPE SVR	62
F-TYPE SVR Aerodynamics	64
F-TYPE SVR Lightweight Technologies	66
F-TYPE SVR Interior	68

PERSONALIZATION

F-TYPE - Your Choice	70
Choose your Engine	72
Choose your Model	74
Choose your Packages	76
Choose your Color	86
Choose your Wheels and Braking System	88
Choose your Interior	90
Choose your Jaguar Gear Accessories	104
Technical Specifications	108
Dimensions	110

JAGUAR WORLD

Jaguar Experience	112
The World of Jaguar	114
Glossary and Legal Information	116



Scan to find out more about F-TYPE

INTRODUCTION

THE CONCEPT OF F-TYPE

The new Jaguar F-TYPE is the latest in a distinguished bloodline of powerful, agile and distinctive sports cars. Combining exhilarating performance, accomplished handling and cutting-edge technology, it delivers an exceptional driver-focused experience.

Latest enhancements ensure it remains as up-to-date as it is special. The range now features the most advanced and efficient engine ever found in an F-TYPE: a 2.0 liter 296HP Turbocharged Ingenium Gas. While Jaguar's most powerful infotainment system, Touch Pro™, is standard with a highly responsive 8" Touchscreen and improved navigation options. Connect Pro offers enhanced connectivity and a range of InControl Apps to make journeys quicker and easier*5. New driver assistance features are also available to make your drive that much more enjoyable.

New LED headlights help drivers distinguish objects more clearly with a quality of beam that is closer to daylight. Exterior styling updates ensure F-TYPE is as striking as when it won 'Design of the Year' at the 2013 World Car Awards. Inside, new slim seats save weight and give more space and comfort, while new finishers on interior details allow even more personalization. And now, the new F-TYPE 400 SPORT Special Edition features a 3.0 liter V6 engine with a unique 400HP tune and exclusive exterior and interior detailing.

F-TYPE is a truly cutting-edge expression of the Art of Performance.

*Please see page 116 for further information.

VEHICLE SHOWN: F-TYPE R-DYNAMIC 2.0 LITER i4 GAS IN SILICON SILVER WITH OPTIONAL EQUIPMENT





F-TYPE - THE FACTS

Stunning design, exhilarating performance, instant response, agile handling and advanced technology. F-TYPE is created to deliver breathtaking driving experiences.

JAGUAR ELITECARE

Enjoy your Jaguar vehicle with complete peace of mind. The F-TYPE is backed by Jaguar EliteCare*⁷, our exceptional 5 year / 60,000 mile coverage program including New Vehicle Limited Warranty, Complimentary Scheduled Maintenance, Roadside Assistance and Jaguar InControl® Remote & Protect™.

*Please see page 116 for further information.

**Comparative weight saving for Performance seats.

†Engine dependent. ‡Only available on F-TYPE R and F-TYPE SVR.

VEHICLE SHOWN: F-TYPE R IN YULONG WHITE WITH OPTIONAL EQUIPMENT

ALL WHEEL DRIVE

The available All Wheel Drive (AWD) system combines the agility and character of Rear Wheel Drive (RWD) with the increased traction provided by AWD. In normal driving, the F-TYPE is predominantly RWD to deliver handling purity, feel and balance. But when needed the system rapidly redistributes torque to the front axle, enabling the F-TYPE to maintain optimum traction in most conditions*⁴.

TECHNOLOGY

The F-TYPE advanced technologies keep you entertained and connected. Available for the first time on the F-TYPE, Park Assist makes parking in tight spaces easier than ever*². Our next-generation of Touch Pro™ infotainment system, with its tablet-style Touchscreen*¹, puts a world of entertainment and 4G Internet connection at your fingertips. The system offers intuitive swipe and pinch-to-zoom navigation, and, with Remote, the option to remotely connect and monitor the F-TYPE wherever you are in the world*⁵.

INTERIOR

Luxury and driver focus find their balance in the F-TYPE. New slimline seats with a lightweight magnesium construction offer improved lateral support and save over 18 lbs** of weight compared with previous generation models. With a redesigned steering wheel, plus the availability of a sporty Sienna Tan interior, the F-TYPE looks just as distinctive on the inside as it does on the outside.

INGENIUM

The Ingenium 2.0 liter 4-cylinder 296HP Turbocharged gas engine is an impressive balance of power. Its low inertia twin-scroll turbocharger features low-friction ball bearings and a mixed flow turbine wheel. Underpinned by the turbocharger's increased aerodynamic efficiency, the engine delivers rapid acceleration and maximum torque of 295 lb-ft between 1,500-4,500 rpm.

SUPERCHARGED PERFORMANCE

V6 and V8 engines use a twin vortex supercharger to eliminate acceleration lag. Throttle response is instantaneous with seamless power delivery and high levels of torque at all engine speeds. The latest engine to use this technology is the V8 unit found in F-TYPE SVR, which makes it the most powerful Jaguar production car ever.



DESIGN

The vehicle's remodelled front end features a redesigned bumper framed by new LED headlights. These elegant headlights adapt the width and depth of their beam and offer a superb quality of light - so you always have the best possible illumination whatever your surroundings.

HANDLING AND AGILITY

To optimize the F-TYPE handling and agility, a range of driving technologies are available. These include Torque Vectoring, Adaptive Dynamics[†] and an Electronic Active Differential^{*2‡}. Each one works to enhance the driving experience through increased control, traction and feel.





DESIGN EXTERIOR PRINCIPLES

DRAMATIC DESIGN

"A piece of design should tell a story. The F-TYPE lines have a start, a direction and a conclusion. Make every line individual and aesthetically correct, with the right dimensions, and a design will stand the test of time."

Ian Callum, Jaguar Design Director

Those bold proportions. Those instinctive curves. Timeless, evocative and progressive in a way that could only be Jaguar.

Some say great design is subjective, but for us there's no debate: the F-TYPE beauty is the ultimate expression of the Art of Performance.

VEHICLE SHOWN: F-TYPE R-DYNAMIC AWD IN SILICON SILVER WITH OPTIONAL EQUIPMENT



EXTERIOR DETAIL

 **POWERFUL FORM**

Rising vertically from the front spoiler and running up through elongated headlights, the beautifully flowing body line of the F-TYPE begins to take shape. The line arcs over the front wheel, descending elegantly as it runs across the door, before culminating in a pronounced muscular rear haunch. Whether you choose Coupe or Convertible, the F-TYPE leaves you under no illusion – this is a performance sports car, the latest in a distinguished bloodline.

VEHICLE SHOWN (LEFT): F-TYPE R-DYNAMIC AWD IN SILICON SILVER WITH OPTIONAL EQUIPMENT
VEHICLE SHOWN (RIGHT): F-TYPE IN INDUS SILVER WITH OPTIONAL EQUIPMENT



It is, in part, sculpted by the wind itself, formed by the Jaguar state-of-the-art Computational Fluid Dynamics design methods. A front splitter beneath the grille and rear venturi manage airflow along the underside, while a deployable rear spoiler** automatically rises at higher speeds to increase downforce and reduce drag. Even the door handles retract when not required, their flush design creating an uninterrupted airflow along the F-TYPE flanks.

**Optional on F-TYPE SVR.

LED HEADLIGHTS



SIGNATURE DESIGN

ENHANCED ILLUMINATION



Even at night, the F-TYPE stands out. The new LED headlights featuring LED 'J' blade Daytime Running Lights are as powerful as they look. These headlights reach further into the darkness than previous generation units, producing a highly focused beam of light with a quality closer to daylight, helping your eyes distinguish objects more easily.

Optional Auto High Beam Assist provides added convenience by automatically dipping the beam when other vehicles are detected*2. 'J' blades complete the dramatic headlight design. These crisp bars of light wrap round each light's outer edge, giving the F-TYPE an instantly recognizable visual signature that adds to its assertive presence and distinctive style.

*Please see page 116 for further information.

VEHICLE SHOWN: F-TYPE R-DYNAMIC AWD IN SILICON SILVER WITH OPTIONAL EQUIPMENT





INTERIOR CONNECTION



DRIVER FOCUS

CLARITY OF DESIGN

In the F-TYPE you and the car become one. Every aspect of its 1+1 configuration is designed to create a bond. It wraps around you, taking your driving experience to greater heights.

The cockpit provides maximum visibility, minimal distractions and close-to-the-center-of-gravity seating for a complete connection with the car. The low fascia is free from clutter to increase the view ahead. The active central air vent, part of the advanced climate control system, hides the two central air vents, which automatically rise from the dashboard when required and retract after use.

The easy to use 8" color Touchscreen*¹ is your primary interaction point with the Touch Pro™ infotainment system. The system responds directly to touch and swipe gestures, providing effortless control over navigation, music, phone, climate and driver assistance features*⁵.

*Please see page 116 for further information.

VEHICLE SHOWN: F-TYPE R-DYNAMIC AWD FEATURING EBONY PREMIUM LEATHER PERFORMANCE SEATS WITH IVORY CONTRAST STITCH WITH OPTIONAL EQUIPMENT





AN EXCLUSIVE SPACE



SUPERIOR CRAFTSMANSHIP

A TAILORED SPACE

We design our interiors so that nothing detracts from the outstanding driving experience. You'll feel comfortably cocooned in the F-TYPE exquisitely crafted cockpit. The styling in the cabin has been subtly refreshed to enhance refinement while maintaining driver focus. Every element of the interior has been reappraised, with updates to even the smallest details, such as the Chrome finishes on the doors and steering wheel, deepening the sense of luxury.

The F-TYPE interior starts with Jaguar's quintessential British character, but its unique personality is up to you. Tailor your interior styling with a variety of stitches and materials including premium leather and suedecloth, as well as Ebony, Pimento, Ivory and Sienna Tan color combinations. It's easy to make the F-TYPE feel truly personal, to make your perfect sports car.

VEHICLE SHOWN: F-TYPE R-DYNAMIC AWD FEATURING EBONY PREMIUM LEATHER PERFORMANCE SEATS WITH IVORY CONTRAST STITCH WITH OPTIONAL EQUIPMENT



LIGHTWEIGHT SEATS



WEIGHT SAVING

COMFORT AND SUPPORT

The new F-TYPE Sport and Performance seats** have been engineered with sports cars in mind. The lighter magnesium construction of the seats saves over 18 lbs** of weight compared with previous generation models. The streamlined form takes up less space enabling a greater range of seating positions. Performance seats provide increased lateral support during dynamic driving and the option of cooling for greater comfort.

**Comparative mass saving for Performance seats. Sport seats are standard on F-TYPE and F-TYPE R-Dynamic. Performance seats are standard on F-TYPE R and F-TYPE SVR and optional on F-TYPE and F-TYPE R-Dynamic.

VEHICLE SHOWN ABOVE AND RIGHT: F-TYPE R-DYNAMIC AWD FEATURING EBONY PREMIUM LEATHER PERFORMANCE SEATS WITH IVORY CONTRAST STITCH WITH OPTIONAL EQUIPMENT







LUGGAGE SPACE

 14.4 CU.FT | OPTIONAL POWERED TAILGATE*

We have designed the cargo space of the F-TYPE Coupe to create a sports car that fits every lifestyle. With a capacity that is up to 14.4 cu.ft (7.3 cu.ft. in F-TYPE Convertible) the F-TYPE Coupe certainly has the space to accommodate two generously sized suitcases for a weekend away. For added ease of access, the tailgate can be opened or closed at the touch of a button with the optional powered function.

*Coupe only.

VEHICLES SHOWN: F-TYPE IN INDUS SILVER AND F-TYPE R-DYNAMIC AWD IN SILICON SILVER WITH OPTIONAL EQUIPMENT

PERFORMANCE ENGINES OVERVIEW



HIGH PERFORMANCE ENGINES

RESPONSIVE POWER

All of the F-TYPE engines deliver high levels of torque and a near instantaneous response to your demand for power.

Making the dynamic performance of the F-TYPE more accessible than ever is a 2.0 liter 4-cylinder 296HP Turbocharged Gas engine from our Ingenium range. It joins our range of outstanding supercharged engines: a 3.0 liter V6 340HP, a 3.0 liter V6 380HP, a 5.0 liter V8 550HP and a 5.0 liter V8 575HP.

Every F-TYPE is fitted with an Active Sports Exhaust that creates a race-car inspired crescendo. The exhaust system reacts to throttle position, speed and engine revs by opening active valves. When open, these valves allow exhaust gases to take a more direct, less restrictive route through the rear silencer producing a much richer, more exhilarating sound. The Switchable Active Exhaust* allows you to manually open the exhaust valves so you can enjoy the stirring soundtrack of the F-TYPE at all engine speeds.



i4 ENGINE

0-60 mph from 5.4 seconds*³

2.0 LITER i4		296HP
Model availability		F-TYPE
Cylinders/Valves per Cylinder		4/4
Bore/Stroke	inches	3.27/3.64
Capacity	cc	1,997
Maximum Power	HP	296
Maximum Torque	lb-ft	295
Compression	ratio:1	9.5

*Optional on F-TYPE, standard on F-TYPE R-Dynamic, F-TYPE R and F-TYPE SVR.

i4 ENGINE

2.0 LITER 4-CYLINDER 296HP

The high performance Ingenium 296HP 2.0 liter 4-cylinder Turbocharged Gas engine produces 295 lb-ft of torque and delivers outstanding driveability.

- The intelligent Continuously Variable Valve Lift (CVVL) system varies the extent to which inlet valves are opened, reducing engine pumping losses. This lets the engine 'breathe' with maximum efficiency, optimizing power and torque.
- CVVL works in combination with dual independent variable cam timing for ultimate operating flexibility, resulting in excellent power and fuel economy across the rev range.
- The twin scroll turbocharger is fed by an integrated exhaust manifold which increases the transfer of energy to the turbine - significantly reducing turbo lag and improving engine response.
- The twin-scroll turbocharger features ceramic ball-bearings which reduce friction and improves transient response.

SINGLE CENTER MOUNTED EXHAUST

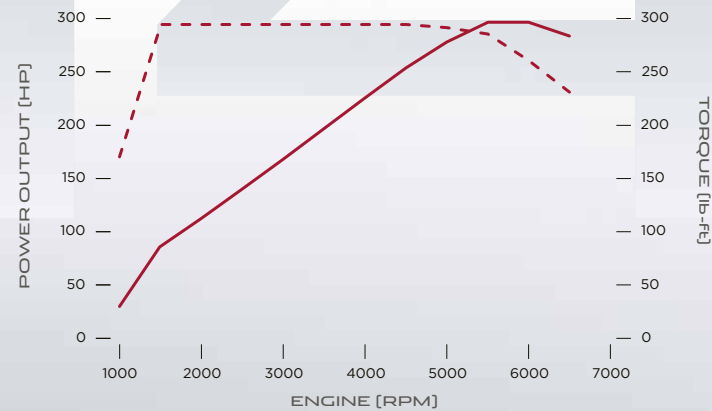

POWER [HP] ——— 296HP
TORQUE [lb-ft] - - - - -

V6 ENGINES



3.0 LITER V6 340HP

3.0 LITER V6 380HP

The 3.0 V6 Supercharged engines balance immediate responsiveness with refined power delivery, giving strong, linear acceleration all the way to the redline. At their core, a lightweight aluminum die-cast block is reinforced with cross-bolted main bearing caps to increase rigidity and refinement. A single balancer shaft and innovative counter-rotating front and rear balancer weights further smooth performance.

Aluminum is also used for the four-valve cylinders, with the valves themselves controlled by dual independent variable cam timing. This timing optimizes power, torque and economy while giving these engines their urgent and responsive character.



V6 ENGINES

0-60 mph from 4.8 seconds*³

3.0 LITER V6 SUPERCHARGED	340HP	380HP
Model availability	F-TYPE	F-TYPE and F-TYPE R-Dynamic
Cylinders/Valves per Cylinder	6/4	6/4
Bore/Stroke	inches 3.33/3.50	3.33/3.50
Capacity	cc 2,995	2,995
Maximum Power	HP 340	380
Maximum Torque	lb-ft 332	339
Compression	ratio:1 10.5	10.5

*Please see page 116 for further information.

To extract more energy from the fuel, giving better fuel economy and high specific power outputs, a spray guided direct injection system carefully manages the air-fuel mixture in the combustion chamber. Mounted in the 'V' between the two banks of cylinders, a compact, twin vortex supercharger uses sophisticated, electronically supervised boost control for efficiency and lag-free bursts of power. Optimizing power and efficiency even further, a water intercooler reduces the temperature of the intake air into the supercharger.

CENTER MOUNTED TWIN EXHAUSTS

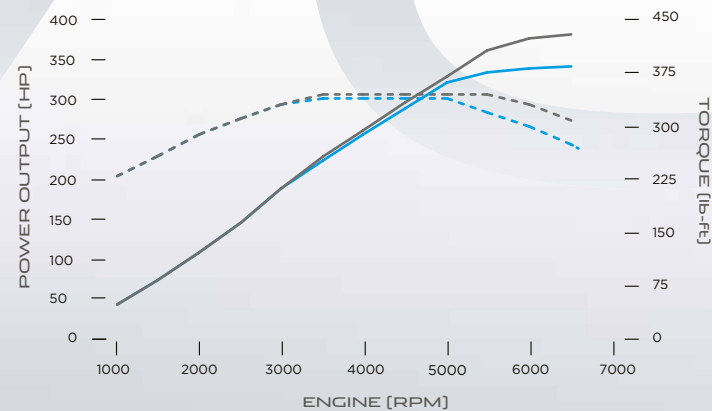

POWER [HP] 340HP 380HP
TORQUE [lb-ft] - - - - - - - - - -

VEHICLE SHOWN: F-TYPE IN YULONG WHITE WITH OPTIONAL FEATURES FITTED

V8 ENGINES



5.0 LITER V8 550HP

5.0 LITER V8 575HP

The higher capacity 5.0 V8 Supercharged engines maximize their greater displacement - offering immense power with high torque for dynamic responsiveness and effortless acceleration. Sharing the same all-aluminum foundations as the 3.0 V6 engines, the V8 engines' blocks are stiffened with cast-iron liners and cross-bolted main bearing caps for increased rigidity and refinement. The V8 models also use dual independent variable cam timing and a single balancer shaft with innovative counter-rotating front and rear balancer mass for the smooth delivery of optimal power.



V8 ENGINES

0-60 mph from 3.5 seconds*³

5.0 LITER V8 SUPERCHARGED	550HP	575HP
Model availability	F-TYPE R	F-TYPE SVR
Cylinders/Valves per Cylinder	8/4	8/4
Bore/Stroke	inches 3.64/3.66	3.64/3.66
Capacity	cc 5,000	5,000
Maximum Power	HP 550	575
Maximum Torque	lb-ft 502	516
Compression	ratio:1 9.5	9.5

A centrally mounted, multi-hole, high pressure direct injection system sprays precisely measured quantities of fuel directly into the center of the combustion chambers to ensure uninterrupted power delivery. The Roots-type twin vortex supercharger features sophisticated boost control and a secondary throttle valve. It ensures that torque curves rise steeply over a broad range of engine speeds, guaranteeing linear power delivery. In both V8 engines, the supercharger is fed by two intercoolers featuring their own water-cooling circuit to reduce the temperature of the pressurised air, meaning more air can reach the engine, optimizing combustion and therefore power output.

OUTBOARD MOUNTED QUAD EXHAUSTS

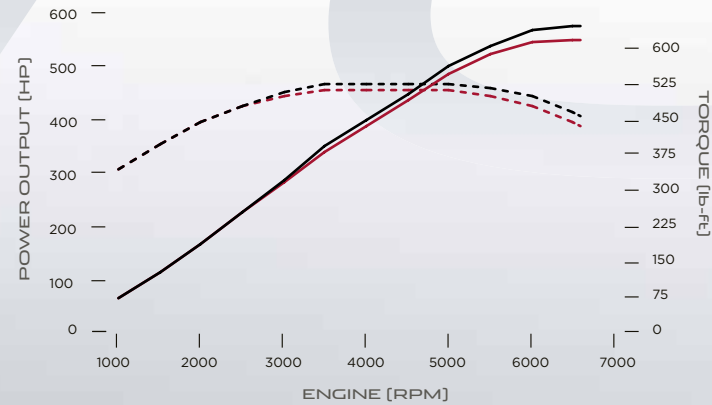

POWER [HP] 550HP 575HP
TORQUE [lb-ft] - - - - - - - -

VEHICLE SHOWN: F-TYPE R IN YULONG WHITE WITH OPTIONAL FEATURES FITTED

LIGHTWEIGHT ALUMINUM ARCHITECTURE



STRONG AND RIGID

HIGH POWER-TO-WEIGHT AND TORQUE-TO-WEIGHT RATIOS



A lightweight aluminum body with a strong, stiff structure is the perfect platform for a sports car. Jaguar pioneered this technology over a decade ago and continues to push the boundaries today. It informs every aspect of how the F-TYPE performs, handles and feels. A strong, stiff structure provides an inherently stable platform for precise, agile handling and allows the finely-tuned suspension system to deliver connectivity and driver feedback. Lightweight aluminum panels are bonded together with a super-strong adhesive, then punched with zinc-coated, boron steel rivets that compress the adhesive to form an airtight bond for phenomenal strength and rigidity. The F-TYPE body is the perfect complement to its high-performance engine range. Together they produce the exceptional power-to-weight and torque-to-weight ratios that deliver the real world measures of performance in a sports car.

The exterior panels are made from specially developed alloys. They combine robustness with greater formability, which gives clarity and tightness to curves and feature lines. On Coupe models, the side pressing is among the most technically advanced. It allows for cleaner lines with an extraordinarily beautiful, uninterrupted sweep from the front pillar to the trailing edge. This combination of advanced materials and innovative techniques has two advantages. It allows us to reproduce the crisp, crafted lines of the F-TYPE, exactly as the designers intended. And it delivers a vehicle with extraordinary structural integrity.

VEHICLE SHOWN: F-TYPE IN INDUS SILVER WITH OPTIONAL EQUIPMENT



F-TYPE

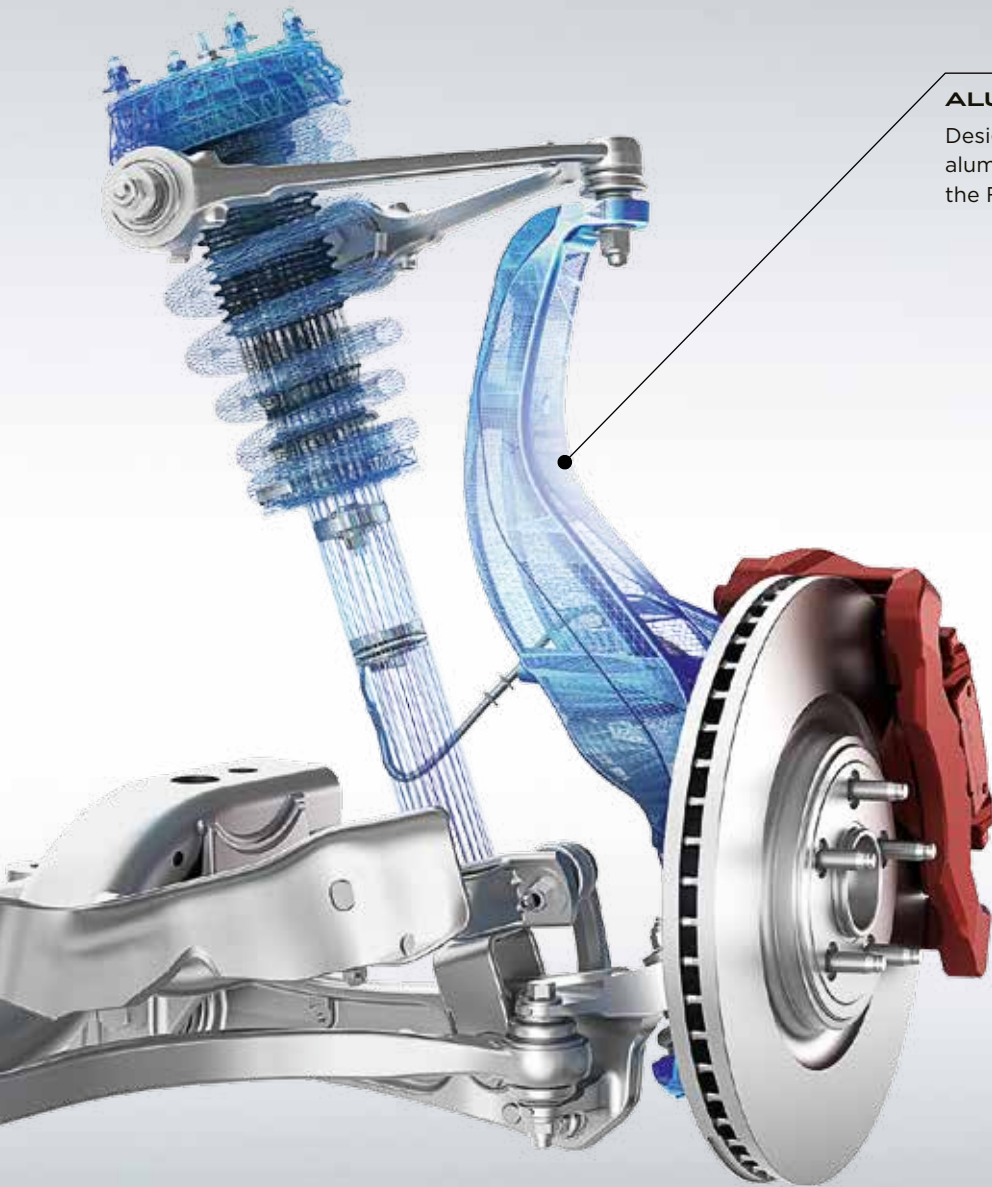

ALUMINUM SUSPENSION KNUCKLES

Designed to improve stiffness and strength, the lightweight aluminum front and rear suspension knuckles help improve the F-TYPE agility and responsiveness.

CHASSIS AND SUSPENSION



CONTROL
AND COMFORT

DYNAMIC
AND REFINED

The Lightweight Aluminum Architecture of the F-TYPE creates a stable platform from which the forged aluminum double wishbone suspension can control the car. With the damping set-up optimized for the best partnership between dynamics and refinement, it gives the perfect combination of control, agility and feedback.

*Please see page 116 for further information.

ADAPTIVE DYNAMICS

Standard on the 3.0L V6 380HP and 5.0L V8 engines, Adaptive Dynamics delivers composed dynamics and a compliant ride. The system assesses body motion and pitch rates 100 times per second. The steering wheel position is also measured 500 times a second enabling the system to predict movements of the F-TYPE. The stiffness of each damper is then adjusted to maintain body control and agility*2.

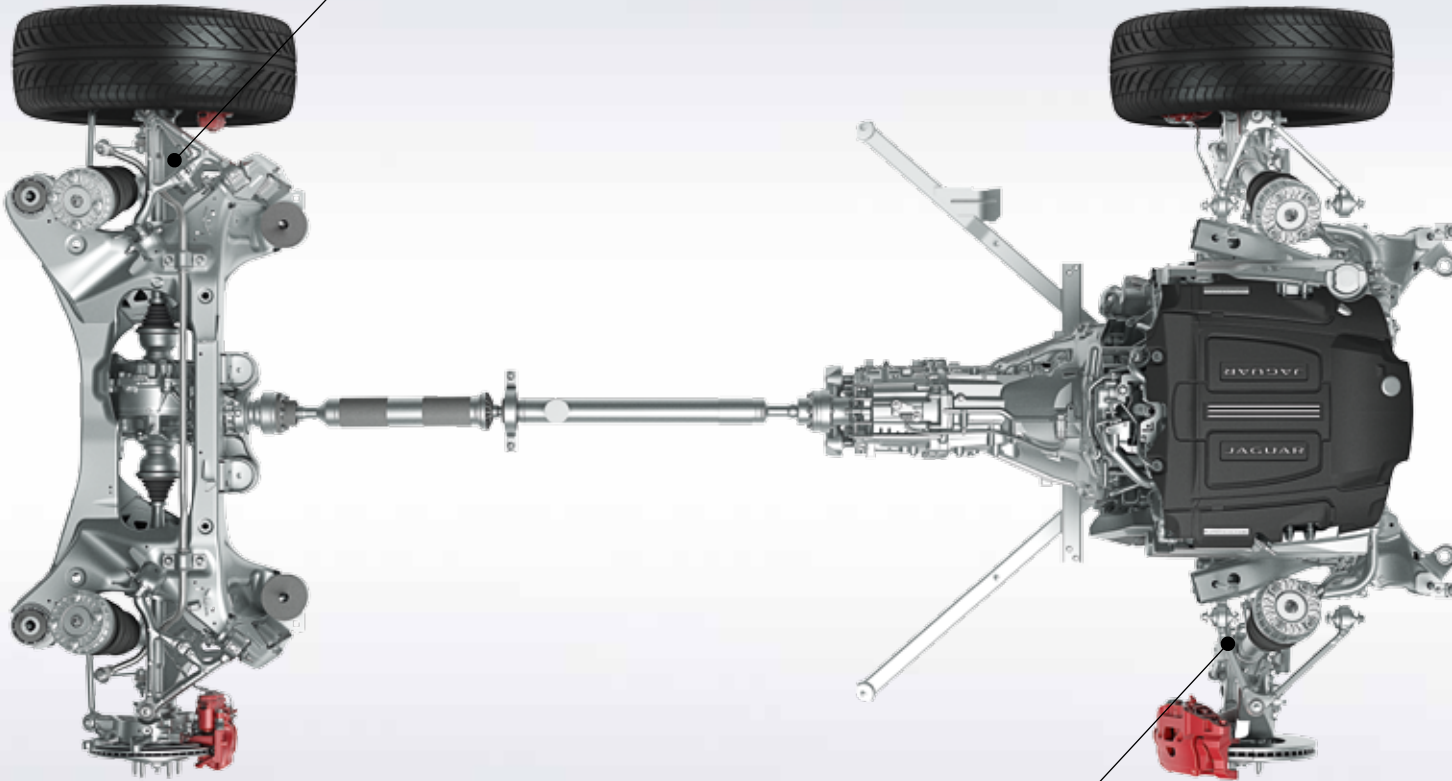

SUSPENSION

Considered by Jaguar as the best configuration for a suspension system, the F-TYPE forged aluminum double wishbone design offers precise handling and control.

ADVANCED AERODYNAMICS



LOW DRAG AND HIGH STABILITY

DEPLOYABLE REAR SPOILER**

Aerodynamic performance is at the heart of the F-TYPE design. It is seamlessly integrated into the body for low levels of lift. Even the door handles retract to create an uninterrupted airflow along its flanks. The deployable rear spoiler** automatically rises at higher speeds to reduce lift by up to 264lbs. A front splitter beneath the grille manages airflow along the vehicle's underside, with the sharply defined tail helping to separate air cleanly at lower speeds. The result is improved handling and stability.

**Optional on F-TYPE SVR.

VEHICLE SHOWN: F-TYPE R IN YULONG WHITE WITH OPTIONAL EQUIPMENT



373 GALLONS

OF RECYCLED WATER PER MINUTE
BLASTED AT EVERY CAR TO ENSURE F-TYPE
IS MONSOON PROOF

10,000,000 HOURS

OF VIRTUAL TESTING, REDUCING OUR IMPACT ON THE
ENVIRONMENT WITH SIGNIFICANT SAVINGS IN RESOURCE,
WASTE, POWER AND FUEL

792,000

VIRTUAL VEHICLES CREATED
BEFORE THE F-TYPE WAS PERFECTED

12,000 MILES

OF EXTREME TRACK TESTING ON GERMANY'S
INFAMOUS NÜRBURGRING RACE TRACK -
EQUIVALENT TO DRIVING HALF WAY AROUND THE WORLD



162°F

DIFFERENCE BETWEEN F-TYPE HOTTEST
(+122°F) AND COLDEST (-40°F) EXTREME CLIMATE
TESTING ENVIRONMENTS

300 TERABYTES

OF PERFORMANCE DATA GATHERED TO REFINE
EVERY INCH OF THE F-TYPE

TESTED TO THE EXTREME



VIRTUAL ANALYSIS

REAL WORLD TRIALS

The F-TYPE first took to the road in the virtual world of Computer Aided Engineering (CAE) systems ensuring that all components underwent extensive development and testing before being committed to the physical testing process. Engineers produced a series of virtual prototypes to realistically simulate the behavior of complex mechanical systems allowing them to analyze multiple variations until the optimum design was achieved. For example, using a technique first used in the aerospace industry, aerodynamic testing took place in a virtual wind tunnel with Computational Fluid Dynamics running on high speed supercomputers. During its virtual life, the F-TYPE completed half a million tests requiring 10 million computer processor hours and creating 300TB of data. The CAE development process was one of the key contributing factors in delivering the exhilarating performance and responsiveness of the F-TYPE.

The real world testing to fine tune the set-up took place in specialized facilities and some of the harshest environments across the globe in temperatures ranging from - 40°F to +122°F, and at altitudes of up to 13,123 ft. The Nordschleife circuit at the Nürburgring in Germany was the perfect location to prove out handling, braking, cooling and durability. Known as the "Green Hell", and featuring 12.94 miles of track with 73 turns, it is renowned as the most demanding circuit in the world and the ultimate test of both car and driver.

VEHICLE SHOWN: F-TYPE R IN YULONG WHITE WITH OPTIONAL EQUIPMENT

DRIVING TECHNOLOGY ADVANCED DRIVING DYNAMICS



MAXIMIZING AGILITY

CONTINUOUSLY ADAPTING

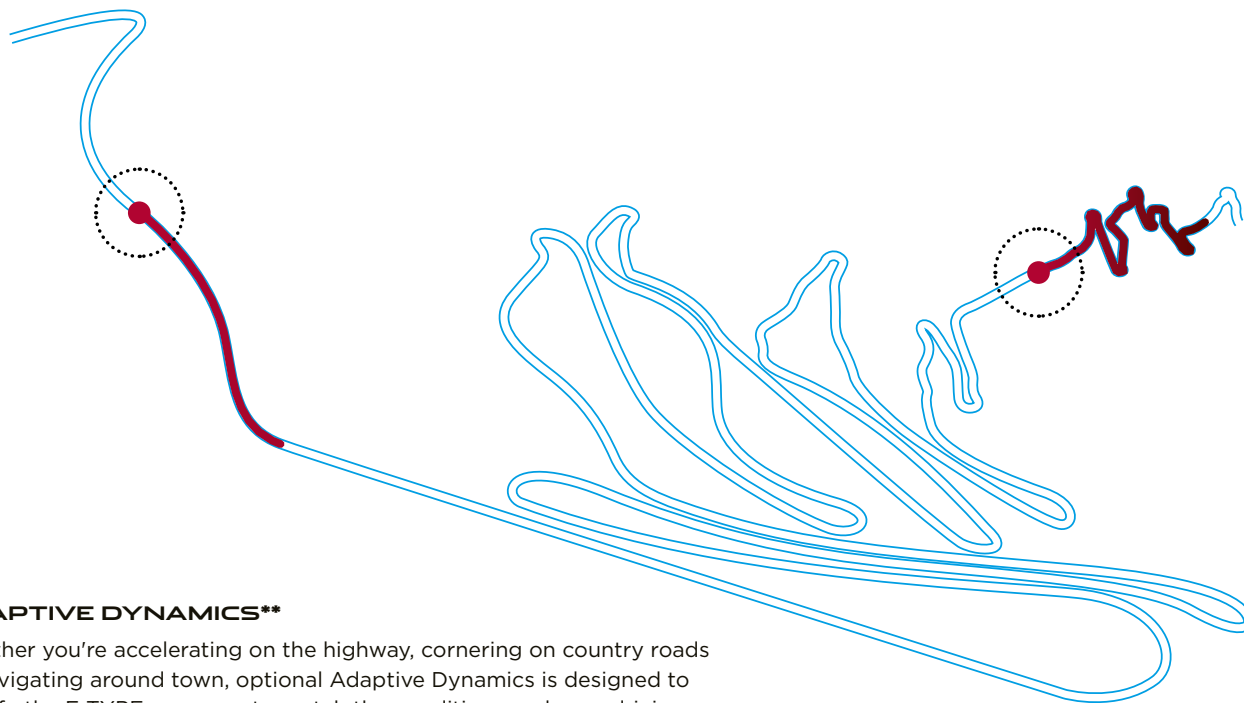

ADAPTIVE DYNAMICS**

Whether you're accelerating on the highway, cornering on country roads or navigating around town, optional Adaptive Dynamics is designed to modify the F-TYPE response to match the conditions and your driving style. It analyzes acceleration, cornering, throttle and brake pedal activity as well as kick-down activation. Steering movement is analyzed up to 500 times a second, and body movement up to 100 times a second. Electronically controlled dampers then constantly adjust to optimize the suspension settings and maintain the F-TYPE dynamism and comfort*².

ELECTRIC POWER ASSISTED STEERING

Electric Power Assisted Steering (EPAS) offers outstanding feedback, control and is active on demand – saving power for where you really need it. This steering system delivers the immediate response and connected feel expected from a Jaguar sports car. Sophisticated computer management varies steering assistance as appropriate – increasing assistance for low speed maneuvering and improving feel at higher speeds*².

*Please see page 116 for further information.

**Only available with the 3.0 V6 380HP engine and 5.0 V8 engines.



INTENSIFIED PERFORMANCE



DYNAMIC MODE

CONFIGURABLE DYNAMICS



Engaging Dynamic Mode amplifies the sporting character of the F-TYPE. On automatic transmission models, gearshifts are faster and at higher engine speeds with automatic upshifts prevented if in Manual Mode, throttle response is sharpened, the dampers are stiffened and steering weighting is increased. Dynamic Mode also opens the Active Sports Exhaust for a more thrilling soundtrack and brings visual drama to the cabin – the F-TYPE instrument cluster and Configurable Ambient Interior Lighting[†] instantly take on a red glow.

The available Configurable Dynamics system^{**} allows you to personalize the F-TYPE Dynamic Mode to create your perfect dynamic setup. Via the Touchscreen, four driving characteristics can be changed to Dynamic or left as normal. So whatever combination of throttle sensitivity, gearbox shift points, steering weighting or damper stiffness you want, Configurable Dynamics allows you to set up Dynamic Mode to suit your driving needs.

^{**}Not available with 2.0 296HP engine or 3.0 340HP engine. Optional on 3.0 380HP engines and standard on F-TYPE R and F-TYPE SVR.

[†]Standard on F-TYPE R and F-TYPE SVR. Optional on F-TYPE and F-TYPE R-Dynamic.



DRY ROAD CONDITIONS

In normal conditions, torque is distributed to the rear wheels, delivering acclaimed Jaguar agility and handling.

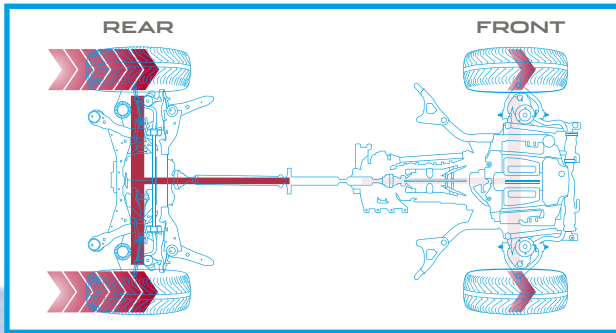

LOW TRACTION CONDITIONS

On slippery surfaces, such as grass and snow, torque can be balanced between the front and rear wheels to improve traction. In extreme conditions where only the front wheels have traction, up to 100 percent of engine torque can be distributed to the front wheels for a more optimal grip.

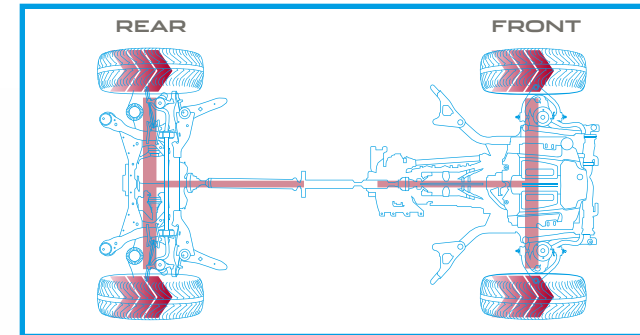

ADVANCED DRIVETRAIN TECHNOLOGY



ALL WHEEL DRIVE

INTELLIGENT DRIVELINE DYNAMICS

The available All Wheel Drive (AWD) system combines the agility and character of Rear Wheel Drive (RWD) with the increased traction provided by AWD. In normal driving, the F-TYPE is predominantly RWD to deliver handling purity, feel and balance. But when roads become more challenging, or when you accelerate on low-grip surfaces, the system subtly channels power forwards enabling the F-TYPE to maintain improved traction for comfortable progress in most conditions*4.

The F-TYPE AWD uses a transfer case at the back of the 8-speed Automatic Transmission to manage the appropriate distribution of torque to the front and rear wheels. Engineered to ensure that the F-TYPE retains the dynamic behavior appropriate for a sports car, the transfer case contains an electro-mechanically activated multi-plate clutch with a smart actuator. Torque is delivered quickly and accurately, via a sophisticated ball ramp mechanism that develops the required force at the clutch, to transfer the optimal amount of torque to the front wheels.

Unlike other systems that react to wheel slip, the Jaguar Intelligent Driveline Dynamics (IDD) software is predictive and uses sensors measuring throttle and steering inputs to anticipate wheel slip. IDD seamlessly coordinates these inputs and compares them with responses from the engine, transmission and traction control systems to calculate the traction available and distribute torque accordingly, even before grip is lost. From a standstill, the F-TYPE can transition from RWD to AWD in as little as 165 milliseconds, or just 100 milliseconds when the car is moving*2.

The result is a drive which blends the character of RWD with the capability of AWD, providing outstanding levels of performance and control whatever the road throws at you.

*Please see page 116 for further information.

TORQUE VECTORING



**INCREASED STEERING
PERFORMANCE**

**ENHANCED
CORNERING CAPABILITY**

The F-TYPE Torque Vectoring improves capability through even the tightest corners. Torque Vectoring technology provides controlled independent braking of the individual, inside front and rear wheels to add to the turning forces acting on the car. In most conditions more braking pressure is applied to the rear inside wheel as this supports the most increased cornering capability, while the front inside wheel is braked for greater effectiveness and refinement. The result is reduced understeer for sharper turning and more consistent road holding*².

Torque Vectoring delivers increased agility and handling. On the F-TYPE R and the F-TYPE SVR, Torque Vectoring works together with the Electronic Active Differential system (see page 46), complementing each other to enhance traction and cornering ability as well as maximizing steering feel and agility*².

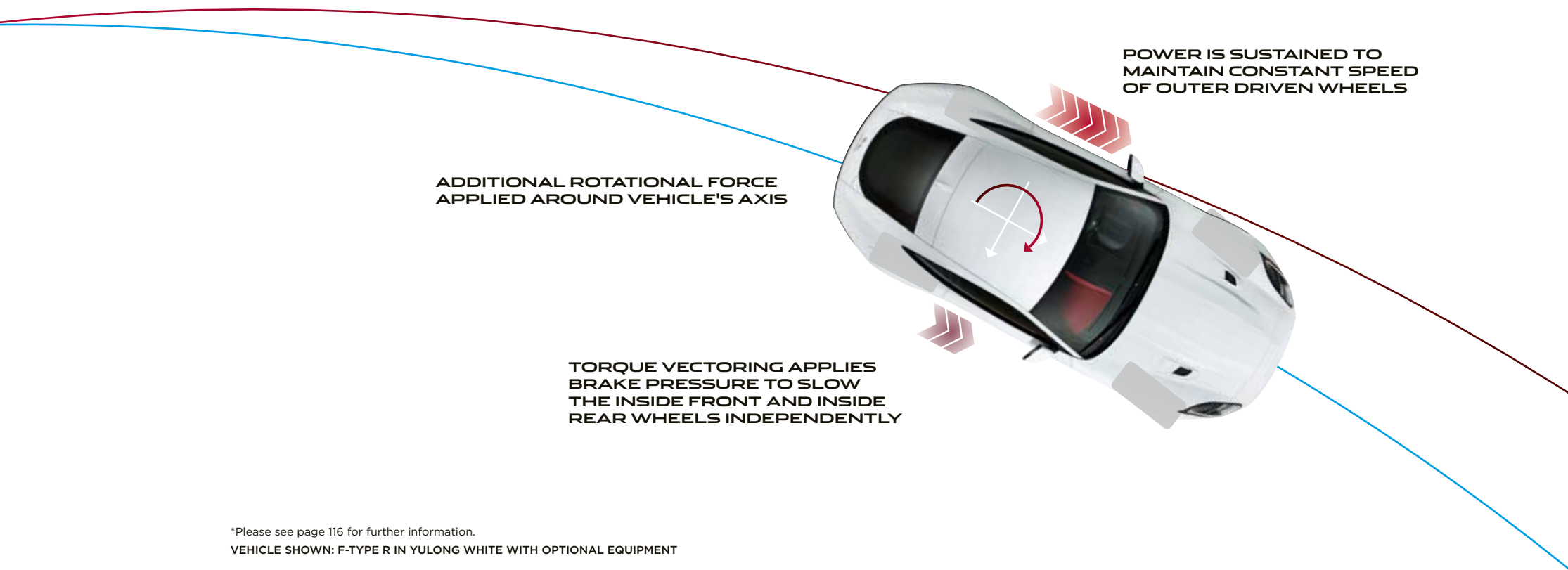

*Please see page 116 for further information.

VEHICLE SHOWN: F-TYPE R IN YULONG WHITE WITH OPTIONAL EQUIPMENT



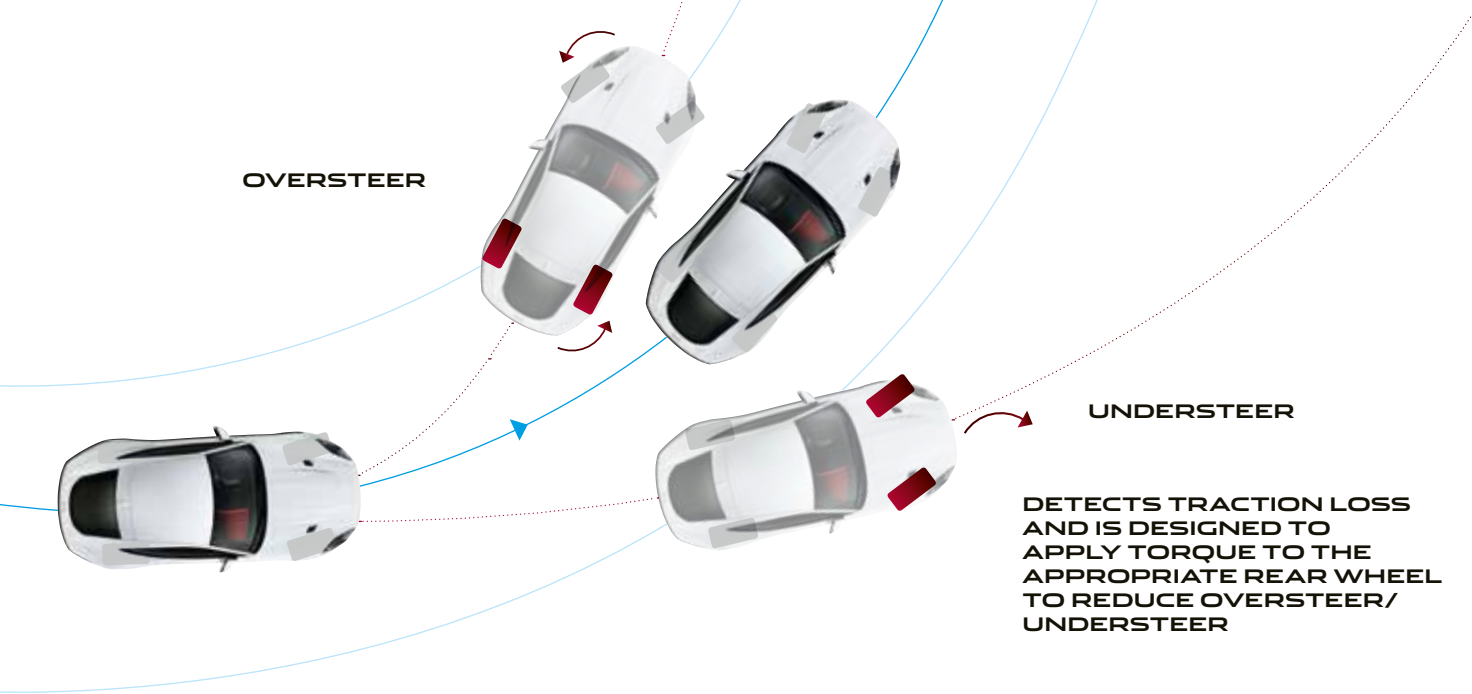

STABILITY AND CONTROL

➤ OUTSTANDING TRACTION | ELECTRONIC ACTIVE DIFFERENTIAL

Jaguar's stability systems are designed to keep the F-TYPE well balanced whether you're driving enthusiastically or simply require the assurance of a car that will remain stable in challenging conditions. To fully harness their performance potential, and for greater control and traction, a Limited Slip Differential is fitted with the 3.0L V6 380HP engine and an Electronic Active Differential is fitted with the 5.0L V8 550HP and 575HP engines*².

Limited Slip Differential: When a rear wheel has low grip, the Limited Slip Differential is designed to transfer torque through a mechanically activated clutch package to the wheel that has more grip. This limits slip across the axle, improving control and traction for faster, more precise cornering*².

Electronic Active Differential: Has a higher locking torque capacity to exploit the increased power and torque of the V8 engines. This differential works with the AWD system and Intelligent Driveline Dynamics (IDD) software, as well as the traction and stability systems, to improve traction and cornering control. Variable electronic control allows this differential to continually adjust locking torque between the wheels - this gives sharper turn in when entering corners and the ability to accelerate sooner when leaving corners because the torque at each wheel is more controllable*².

*Please see page 116 for further information.

VEHICLE SHOWN: F-TYPE R IN YULONG WHITE WITH OPTIONAL EQUIPMENT





JAGUAR
CARBON CERAMIC

PERFORMANCE BRAKING SYSTEMS

> LIGHTWEIGHT | POWERFUL | DURABLE

A range of braking systems are available, each one engineered to deliver a confident, progressive feel and consistent high performance. The calipers use aluminum to reduce the unsprung mass of the car, benefiting both handling and ride refinement. Each system features large, ventilated brake discs – up to 398mm in diameter on the Carbon Ceramic system. This large swept area improves braking force as well as providing greater capacity for the discs to absorb and dissipate the heat energy generated during braking.

Jaguar's Carbon Ceramic Braking system, with its striking Yellow monobloc calipers is the most powerful braking system fitted to a Jaguar road car. It offers up to 46lbs of weight saving, further reducing unsprung mass. With greater resistance to fade and wear, it is designed to deliver sustained performance in demanding conditions.

355MM FRONT AND
325MM REAR BRAKES



CALIPERS: SILVER (STANDARD)
STANDARD ON F-TYPE 296HP and 340HP

380MM FRONT AND
325MM REAR BRAKES



CALIPERS: BLACK (STANDARD) OR RED (OPTIONAL)
STANDARD ON F-TYPE 380HP AND
F-TYPE R-DYNAMIC 380HP

380MM FRONT AND
376MM REAR BRAKES



CALIPERS: RED (STANDARD) OR BLACK (OPTIONAL)
STANDARD ON F-TYPE R AND F-TYPE SVR
OPTIONAL ON F-TYPE 380HP AND
F-TYPE R-DYNAMIC 380HP

398MM FRONT AND
380MM REAR CARBON
CERAMIC BRAKES



CALIPERS: YELLOW (STANDARD)
OPTIONAL ON MODELS WITH AUTOMATIC
TRANSMISSION*

*Not available with 2.0 296HP or 3.0 340HP engine.

For more details on brake availability refer to page 88 or configure your vehicle at jaguarusa.com

JAGUAR INCONTROL® TECHNOLOGIES INFOTAINMENT AND CONNECTIVITY



Jaguar InControl® is our suite of advanced technologies that link you to your F-TYPE, and both you and your F-TYPE to the wider world.

Every F-TYPE now features the Touch Pro™ infotainment system as standard. Incredibly responsive, with a highly intuitive user interface and sharp graphics, Touch Pro™ is the most advanced infotainment system that Jaguar has ever created. Its technologies, including a quad-core processor and a high-speed 60GB solid-state drive, ensure Touch Pro™ makes every journey easier and more enjoyable*⁵.

This outstanding technology is further enhanced by its connectivity package: Connect Pro.

TOUCH PRO*⁵



STANDARD

- 8" Touchscreen with multi-touch gestures and customizable homescreens
- Instrument Cluster with 5" Central TFT Display
- Navigation Pro
- Sirius XM® Satellite Radio*⁶ and HD Radio™
- Bluetooth® and 2 x USB connections
- Meridian™ Sound System (380W)



- Connect Pro** consists of InControl Apps, Remote smartphone app, 4G Internet connection and Pro Services



- Protect** consists of SOS Emergency Call, Jaguar Optimized Assistance and Stolen Vehicle Locator

OPTIONAL FEATURES

- Meridian™ Surround Sound System (770W)

*Please see page 116 for further information.

Third Party programs or applications may require an end user license from the supplier.

As Jaguar rolls out InControl, specific features described may be optional, and market or powertrain dependent. Please consult your country-specific Jaguar website or local Jaguar Retailer for availability and full terms in your country. Certain features require a Micro SIM with a suitable data contract which will require further subscription after the initial term advised by your Retailer. Mobile connectivity cannot be guaranteed in all locations.



JAGUAR F-TYPE

David's F-TYPE

29°

FUEL

RANGE 410 Miles

ODOOMETER 3473 Miles

Vehicle Locked And Alarmed

Beep & Flash

BARCELONA

Directions to your vehicle



SWIPE



PINCH



ZOOM

TOUCH PRO™



NEXT GENERATION INFOTAINMENT

The next-generation hardware and software Touch Pro™ advances the F-TYPE connectivity and entertainment to the very highest level*⁵.

The key aspects of Touch Pro™ are*⁵:

8" Touchscreen at the heart of the center console with customizable homescreen and lightning fast response times*⁵.

Pinpoint touch control allows you to manipulate and interact with information swiftly and seamlessly. The Touchscreen responds in the same manner as a smartphone or tablet computer, providing multi-touch gestures such as pinch, zoom and swipe*⁵.

Navigation Pro has response times that are a fraction of conventional systems. Set a destination and the system alerts you if you have insufficient fuel for the journey. It then displays gas stations on the part of the route where you may be low on fuel. The system also automatically displays parking options.

CONNECT PRO



ENHANCED CONNECTIVITY

The Connect Pro services, technologies and applications give you the very best in connectivity and convenience, all supported by a fast 4G Internet connection. It offers many features including*⁵:

InControl Apps™ features a range of Jaguar approved apps that can be connected to F-TYPE from your smartphone. It ensures convenient use of apps optimized to enhance aspects of your in-car experience*⁵.

Remote is an app that allows you to monitor as well as interact with your F-TYPE from your smartphone. Remote start your vehicle to start the climate control, lock or unlock the car, locate your F-TYPE on a map or in person by using the beep and flash function, and track your trips.

Pro Services is a comprehensive suite of connected services that includes:

Real Time Traffic uses millions of live traffic data feeds to give a highly accurate picture of traffic on the way to your destination, helping you choose the best route. As you progress, the system continues to monitor live traffic conditions, and can automatically reroute you to help avoid congestion.

Route Planner Companion App allows you to pre-plan your route via your Apple® or Android™ smartphone. It guides you to your car, where you will find your selected route available on the F-TYPE Touchscreen. When you've completed your trip, the app guides you to your final destination.

Share your estimated time of arrival so your selected contact(s) will know when you will arrive, as calculated by the navigation guidance system. The system can then send automatic updates via text or email, without any further action from you.

Commute Mode allows the system to learn your commutes and automatically advises you of the expected journey time and quickest routes based on live and historical traffic movements.



Explore Jaguar InControl® at jaguarusa.com

*Please see page 116 for further information.

Certain features require a Micro SIM with a suitable data contract which will require further subscription after the initial term advised by your Retailer. Mobile connectivity cannot be guaranteed in all locations.

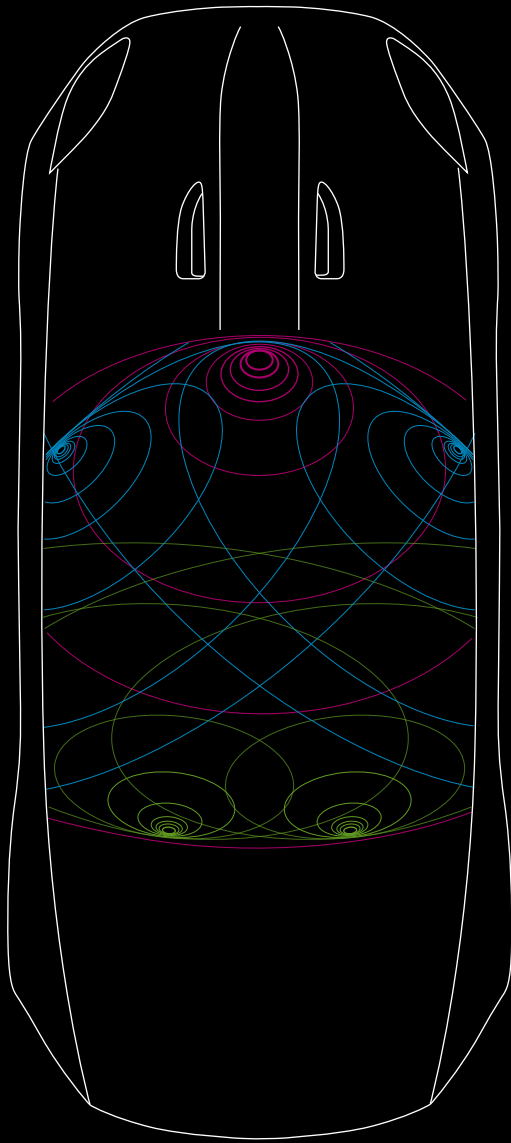

AUDIO



MERIDIAN™ SOUND AND
SURROUND SOUND SYSTEMS

ADVANCED
TECHNOLOGY

Working with British audio experts Meridian™, we designed two high specification systems specifically for the F-TYPE.

Digital Signal Processing (DSP) optimizes Meridian's advanced Cabin Correction algorithm. This tailors the music to the unique acoustics of the F-TYPE interior. Dynamic Volume Control compensates for changes in sound levels, so you hear consistent sound through 10 speakers including 2 subwoofers, 380W and 10 channels.

The ultimate Meridian™ Surround Sound System for F-TYPE delivers 770W through 12 speakers. Using Meridian's exclusive Trifield™ technology, this advanced system delivers an authentic and consistent music experience.



-  Holographic Center Image
-  Door Waves: Tweeter, Midrange and Bass
-  Surround Sound Waves

Diagram representative of Meridian™ Surround Sound System (770W).



MERIDIAN

Standard



380

WATTS

10

SPEAKERS INCLUDING
2 SUBWOOFERS

10

AMPLIFIER CHANNELS

MERIDIAN™ SOUND SYSTEM

Dynamic Volume Control
380 watts
10 speakers including 2 subwoofers
10 channel class D DSP amplifier

Optional



770

WATTS

12

SPEAKERS INCLUDING
2 SUBWOOFERS

13

AMPLIFIER CHANNELS

MERIDIAN™ SURROUND SOUND SYSTEM

Dynamic Volume Control
770 watts
12 speakers including 2 subwoofers
13 channel class D DSP amplifier
Audyssey MultEQ Audio Equalization
7.1 Surround Sound
Meridian Trifield™ Technology

'Trifield' and the 'three fields' device are trademarks of Trifield Productions Ltd.
VEHICLE SHOWN: F-TYPE R IN YULONG WHITE WITH OPTIONAL EQUIPMENT

ADVANCED DRIVER ASSISTANCE

The advanced technology in the F-TYPE is designed to take the stress out of driving. It can help with everything from reducing the chance of a highway collision to avoiding minor bumps in a parking lot. This range of driver assistance systems give you the reassurance, information and control to focus on the pleasure of the drive.



PARKING AIDS

The optional front and standard rear parking aids are designed to alert the driver with an audible warning to the presence of nearby objects. Symbols on the center console Touchscreen provide further information on their location in relation to the vehicle*2.



PARK ASSIST

The optional Park Assist system is designed to make parallel parking in a tight spot easier than ever by steering your car into a suitable space. You just have to select the appropriate gear and control the car's speed. Park Assist will also steer you out of a space, taking the stress out of parking. Graphics and notifications guide you through both maneuvers*2.



REAR VIEW CAMERA

This standard feature combines a rear-facing camera with Touchscreen information. It features colored distance guides and on-screen guidance lines that move according to steering wheel angle to indicate the area into which the car will reverse*2.

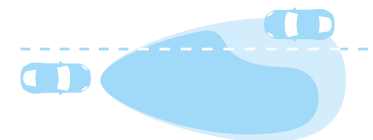

AUTO HIGH BEAM ASSIST

The optional Auto High Beam Assist system automatically switches between low and high beam when necessary, using a sensor mounted at the front of the rear view mirror*2.

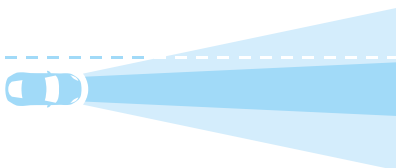

LED FRONT LIGHTING SYSTEM

This system is designed to provide better illumination in a variety of situations by adjusting the headlight beam to your speed and the weather conditions. At slower speeds it widens the low beam to illuminate your peripheral vision, helping you to see pedestrians and Intersections. At higher speeds the system raises and narrows the low beam for extended visibility*2.



PEDESTRIAN CONTACT SENSING SYSTEM

Help protect the people outside your car as well as those inside. If the car makes contact with a pedestrian, our standard Pedestrian Contact Sensing System is designed to automatically raise the hood to help cushion a potential impact*2.



EMERGENCY BRAKING†

If a potential collision is detected, the car will give you a forward collision warning, giving you time to take action. If a collision is still anticipated and you have taken no action, our standard Braking system is designed to apply the brakes to help reduce the severity of the possible impact*2.



EMERGENCY BRAKE ASSIST

If the brakes are applied rapidly, this standard system boosts braking force to the maximum for shorter stopping distances. It can also help retain greater steering control in unexpected situations*2.

*Please see page 116 for further information.

†Feature introduced on the Jaguar F-TYPE model at mid model year. For information regarding the availability of this feature on your vehicle, please contact your authorized Jaguar Retailer.

For more details on feature availability refer to pages 78-85 or configure your vehicle at jaguarusa.com. For information on airbags refer to page 78.

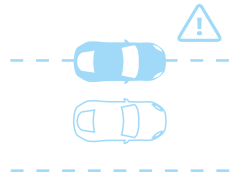

LANE DEPARTURE WARNING†

Our standard Lane Departure Warning can help make long trips much easier. It is designed to sense when your car is unintentionally drifting out of your lane, and to notify you with a visual alert and a gentle vibration of the steering wheel*2.

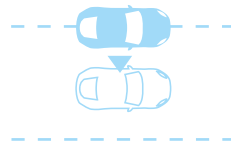

LANE KEEP ASSIST

Optional Lane Keep Assist can help make long trips much easier. It senses when your car is unintentionally drifting out of your lane, and is designed to gently steer you back*2.

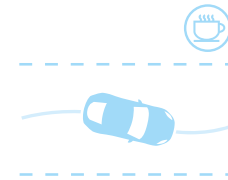

DRIVER CONDITION MONITOR

Our optional Driver Condition Monitor knows if you're starting to feel drowsy or fatigued - giving you an early warning when you need to take a break*2.



TRAFFIC SIGN RECOGNITION AND ADAPTIVE SPEED LIMITER

Our optional Traffic Sign Recognition system keeps you fully informed and aware on the road, by displaying speed limits and no passing signs in the instrument cluster where they can easily be seen. When activated, our Adaptive Speed Limiter uses Traffic Sign Recognition information to adjust your car's speed accordingly*2.



BLIND SPOT MONITOR AND REVERSE TRAFFIC DETECTION

Optional Blind Spot Monitor is designed to alert you to vehicles or obstacles beside the F-TYPE, as well as ones approaching from a distance behind, via an icon displayed in the appropriate exterior mirror. Reverse Traffic Detection alerts you via the Touchscreen of moving vehicles during reversing.



F-TYPE 400 SPORT SPECIAL EDITION

Available for 18 model year only, the F-TYPE 400 SPORT is powered by an exclusive 400HP tune of the 3.0 V6 Supercharged engine. The added 20HP of power at the top of the rev range encourages you to push on into the high revs, towards the redline, where you can enjoy an even more dynamic drive. The F-TYPE 400 SPORT has a potent combination of design features to match the increased engine power*³.

A muscular Sport Design Package with sleek Dark Satin Grey trim strengthens on-road presence. Even the interior has added edge, with many design features carrying the bright 400 SPORT motif or Yellow contrast stitching. To complement the distinctive style, the F-TYPE 400 SPORT is available exclusively in Indus Silver, Santorini Black, or Yulong White metallic paint colors.

UNIQUE F-TYPE 400 SPORT FEATURES

- 3.0 V6 400HP Supercharged Gas engine available in Coupe or Convertible body style, RWD or AWD and automatic transmission.

Exterior:

- Sport Design Package with Dark Satin Grey and Gloss Black accents
- Black brake calipers with Yellow 400 SPORT script
- 20" Dark Satin Grey alloy wheels

Interior:

- Premium leather interior with Yellow twin-needle stitching
- Windsor leather 400 SPORT Performance seats
- Interior Black Package
- Aluminum gearshift paddles
- Interior 400 SPORT branding

To see the complete list of F-TYPE 400 SPORT standard features, and the extensive range of options and accessories available, visit jaguarusa.com

*Please see page 116 for further information.



400
SPORT



THE THEATER OF DREAMS

SPECIAL VEHICLE OPERATIONS

JAGUAR'S CENTER OF EXCELLENCE

Special Vehicle Operations (SVO) assembles and hand finishes halo models and limited run collector's editions, including the new F-TYPE SVR. Each one showcases the best of Jaguar with stunning performance, exceptional luxury and cutting-edge technology. With a dedicated team of designers, engineers and technicians, SVO takes precision engineering to new heights and offers the opportunity for more individuality, choice and personalization. A car from SVO is the ultimate expression of Jaguar.

SVO is based at a brand new Technical Center in Warwickshire, England. This 215,000 sq ft specialty manufacturing facility has been established to enable our most discerning clients to indulge their passion for Jaguar. Our state-of-the-art facility features over 40 engineering inspection stations, a commissioning suite and an environmentally sustainable world-class paint facility.





THE CONCEPT OF F-TYPE SVR



STATE-OF-THE-ART MATERIALS

ADVANCED AERODYNAMICS

The F-TYPE SVR is designed and engineered at Special Vehicle Operations where our highly skilled engineers and aerodynamics experts have scrutinized every possible component to maximize performance. In both Coupe and Convertible form, it is the ultimate F-TYPE. State-of-the-art materials and advanced aerodynamic design push F-TYPE beyond the extraordinary with an exceptional powertrain that makes the F-TYPE SVR our fastest production car ever. Delivering supreme performance, ride and handling, F-TYPE SVR creates once-in-a-lifetime driving experiences – every day.

The F-TYPE SVR lightweight All Wheel Drive system, with Intelligent Driveline Dynamics (IDD), delivers the engine's power with efficiency and control*². The 5.0 V8 engine has been recalibrated to produce 575HP and 516 lb-ft of torque, with a power-to-weight ratio of 6.5 lbs/HP**³. It will take you from 0-60 mph in just 3.5 seconds*³ and on to a top speed of 200 mph**³. But it is about more than numbers, more than just a machine. Jaguar makes performance an art. The F-TYPE SVR is our latest masterpiece.

*Please see page 116 for further information **Coupe only.





F-TYPE SVR AERODYNAMICS



**MAXIMIZED
CAPABILITY**

**ADJUSTABLE
DOWNFORCE**

The performance of the F-TYPE SVR is not expressed by its exterior design: it is created by it. Form follows function in every swooping curve and finely drawn line. Each unique styling element, down to the smallest, subtle detail, improves the F-TYPE SVR. Its advanced aerodynamic design offers less drag and higher levels of downforce. As a result F-TYPE SVR slices cleanly through the air, achieving rapid acceleration and effortlessly efficient cruising. Strong downforce improves stability and handling, road holding and dynamic capability.

FRONT INTAKES AND SPLITTER

Unique large lower bumper intakes maximize airflow for cooling of both the engine and brakes for improved performance. A precision splitter designed specially for the F-TYPE SVR directs airflow into the car for optimum cooling. It also creates downforce at the front of the car to balance the rear spoiler.

HOOD LOUVERS AND SIDE POWER VENTS

Uniquely shaped louvers maximize airflow through the engine bay. This aids cooling, so the engine can operate at the highest level. Air from the wheel housing is released through side power vents which manage airflow around the wheel arch to minimize drag.

ENHANCED COOLING

The cooling system has been enhanced with significant improvements to airflow. To achieve this, the auxiliary radiator has been relocated, while the bumper beam profile and inlet trumpet size have been reduced. This increases the full performance envelope on the F-TYPE SVR for greater endurance in extreme driving situations.

VEHICLE SHOWN ABOVE: F-TYPE SVR IN CALDERA RED WITH OPTIONAL EQUIPMENT
VEHICLES SHOWN ON PREVIOUS PAGES: F-TYPE SVR IN CALDERA RED WITH OPTIONAL EQUIPMENT



AERODYNAMIC SPOILER

The aerodynamic spoiler is integral to the enhanced performance of the F-TYPE SVR. Compared with the standard F-TYPE Coupe rear spoiler, the F-TYPE SVR produces more downforce but crucially less drag. The active spoiler is more elevated and wider than the standard F-TYPE Coupe spoiler, enabling it to act over the whole width of the car.

Air passes both over and under the spoiler, allowing Bernoulli's principle to act in the car's favor, faster moving air underneath the spoiler is at a lower pressure than that passing over the top, resulting in additional downforce.

The F-TYPE SVR spoiler operates in two different positions:

On the Coupe the aerodynamic spoiler deploys at 70 mph and stores at 50 mph*³.

On the Convertible the aerodynamic spoiler deploys at 60 mph and stores at 40 mph*³.

DEPLOYED SPOILER

When the F-TYPE SVR spoiler is deployed it increases downforce for greater stability and improved handling at top speed. In this position the spoiler gives a drag coefficient reduction of 2.5 percent and a lift coefficient reduction of 15 percent.

STORED SPOILER

For maximum top speed (V-Max), the spoiler is stored to reduce drag. It works in conjunction with the front spoiler and other aerodynamic enhancements to bring a drag coefficient improvement of 7.5 percent and lift coefficient reduction of 45 percent.

V-MAX

In order to achieve 200 mph*³ you must consciously prepare your F-TYPE SVR. Select 'Dynamic Mode' and press the deployable aerodynamic spoiler switch for 3 seconds to enable V-Max Mode. While active, a permanent symbol appears on the instrument cluster. In this mode the spoiler remains stored at all speeds keeping drag to a minimum.

REAR UNDERFLOOR AND DIFFUSER

The smooth rear underfloor reduces drag, while the rear diffuser works with the rear underfloor to manage airflow, adding to the stability of the F-TYPE SVR.

*Please see page 116 for further information.

³Coupe only.



108 SOM

F-TYPE

F-TYPE SVR LIGHTWEIGHT TECHNOLOGIES



WEIGHT SAVING

INNOVATIVE DESIGN

Weight is the enemy of performance. So we designed the F-TYPE SVR to be as lean as possible. Every pound has a reason to be there. Every ounce saved gives you more rapid acceleration, more agile handling and sharper braking. Yet the interior still offers comfort and luxury in equal measures. The F-TYPE SVR has the capability to make performance effortlessly enjoyable.

FORGED ALLOY WHEELS

The bespoke Forged alloy wheels of the F-TYPE SVR are fitted with unique Pirelli P ZERO™ tires. Its tires are 10mm wider than standard F-TYPE tires, for improved handling and grip. While the striking Forged alloys offer a 30.4 lbs overall weight saving.

CERAMIC BRAKES

The optional CCM brakes on the F-TYPE SVR save up to 46 lbs of weight compared with non-ceramic alternatives.

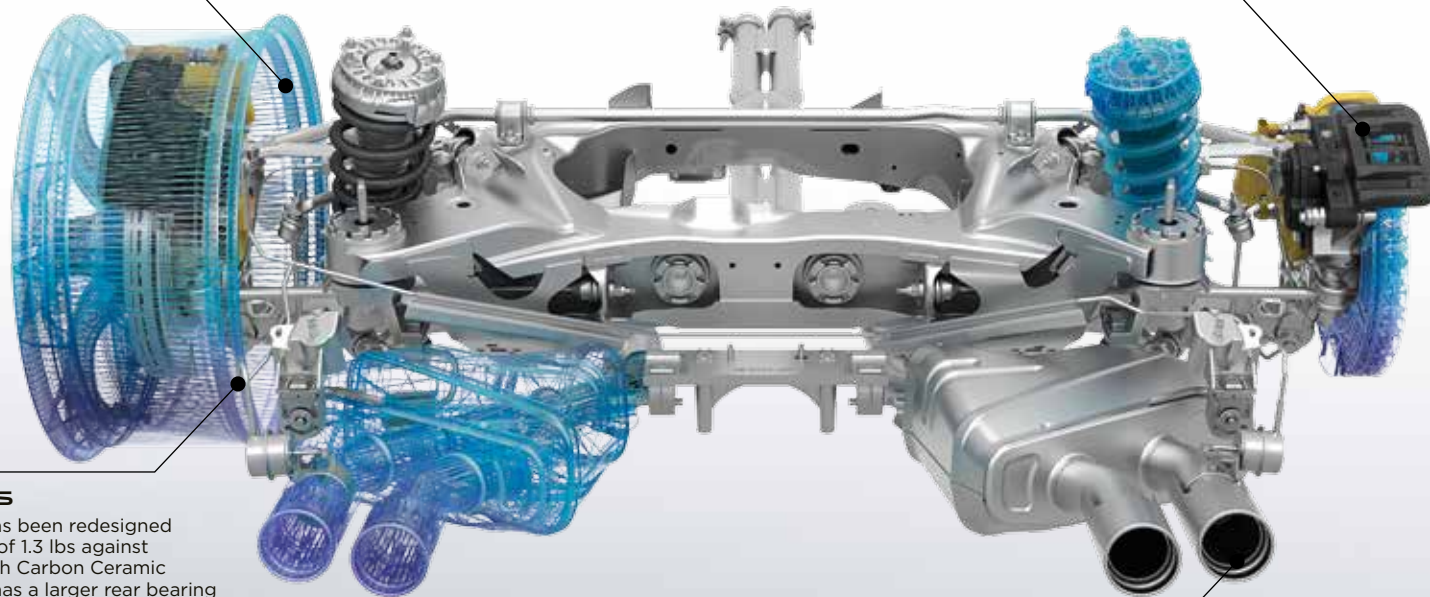

REAR KNUCKLES

The suspension system has been redesigned enabling a weight saving of 1.3 lbs against conventional knuckles with Carbon Ceramic brakes. The F-TYPE SVR has a larger rear bearing that contributes towards an increased stiffness of up to 37 percent over the standard F-TYPE knuckles. This enables the car to handle even higher lateral G-forces.

TITANIUM EXHAUST

The lightweight Titanium and Inconel® exhaust system saves 35.2 lbs. With its SVR badged tailpipes, it not only looks unique, it sounds unique – F-TYPE SVR is recognizable by the distinctive rumble of its exhaust.



F-TYPE SVR INTERIOR

 **UNIQUE DETAILS** | **SPORTING CRAFTSMANSHIP**

Just as no detail of the engineering and exterior design of the F-TYPE SVR has been overlooked, its interior is testament to the SVO division's attention to detail. The moment you open the door, the SVR treadplate shows that you are entering a special space.

Exclusive materials are everywhere you look, from fine contrast stitching to ultra-modern finishes that create a sense of total luxury. The SVR badged steering wheel with larger aluminum anodized gearshift paddles offers the perfect connection to the road and the quilted Performance seats offer comfort and support while you enjoy the dynamic drive.

VEHICLE SHOWN: F-TYPE SVR FEATURING EBONY QUILTED LEATHER PERFORMANCE SEATS WITH CIRRUS STITCH AND MICRO PIPING AND OPTIONAL EQUIPMENT



PERSONALIZATION F-TYPE - YOUR CHOICE

 Configure your vehicle at jaguarusa.com



CHOOSE YOUR ENGINE

Page 72

Select a powerful F-TYPE engine to suit your driving style.

CHOOSE YOUR MODEL & PACKAGES

Page 74

Compare the wealth of standard features and options on the F-TYPE models.

CHOOSE YOUR COLOR

Page 86

Express your individuality with one of the F-TYPE stunning exterior colors.



CHOOSE YOUR
**WHEELS AND
BRAKING SYSTEM**

Page 88

Complement the stunning style of the F-TYPE with a set of beautifully designed alloy wheels.

CHOOSE YOUR
INTERIOR

Page 90

There's a wide selection of premium materials, leathers and finishes for every personal taste.



CHOOSE YOUR
**JAGUAR GEAR
ACCESSORIES**

Page 104

Really make it yours by adding style, practicality and versatility with official F-TYPE Gear Accessories from your local Jaguar Retailer.

1 CHOOSE YOUR ENGINE

 Configure your vehicle at jaguarusa.com

> i4 ENGINE

2.0 LITER i4

TURBOCHARGED GAS [296HP] RWD
AUTOMATIC

MAXIMUM POWER 296HP

MAXIMUM TORQUE 295 lb-ft

ACCELERATION 0-60 mph*³
5.4 seconds*³

TOP SPEED 155 mph*³

F-TYPE, F-TYPE R-DYNAMIC

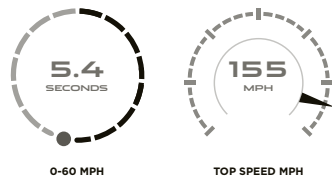

> V6 ENGINES

3.0 LITER V6

SUPERCHARGED GAS [340HP] RWD
MANUAL OR AUTOMATIC

MAXIMUM POWER 340HP

MAXIMUM TORQUE 332 lb-ft

ACCELERATION 0-60 mph*³
Manual 5.5 seconds*³ / Auto 5.1 seconds*³

TOP SPEED 161 mph*³

F-TYPE

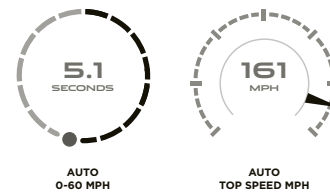
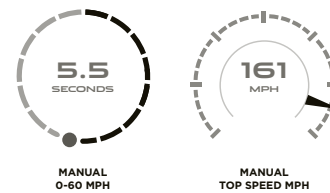

3.0 LITER V6

SUPERCHARGED GAS [380HP] RWD
MANUAL[†] OR AUTOMATIC

MAXIMUM POWER 380HP

MAXIMUM TORQUE 339 lb-ft

ACCELERATION 0-60 mph*³
Manual[†] 5.3 seconds*³ / Auto 4.8 seconds*³

TOP SPEED 171 mph*³

F-TYPE, F-TYPE R-DYNAMIC

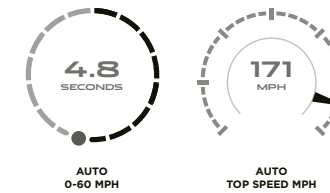
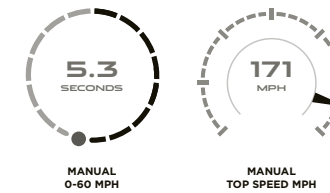

*Please see page 116 for further information.
[†]F-TYPE R-Dynamic only.

➤ V8 ENGINES

3.0 LITER V6

SUPERCHARGED GAS [380HP] AWD
AUTOMATIC

MAXIMUM POWER 380HP

MAXIMUM TORQUE 339 lb-ft

ACCELERATION 0-60 mph 4.9 seconds*³

TOP SPEED 171 mph*³

F-TYPE, F-TYPE R-DYNAMIC



0-60 MPH

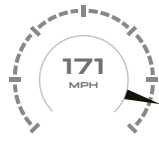

TOP SPEED MPH

5.0 LITER V8

SUPERCHARGED GAS [550HP] AWD
AUTOMATIC

MAXIMUM POWER 550HP

MAXIMUM TORQUE 502 lb-ft

ACCELERATION 0-60 mph 3.9 seconds*³

TOP SPEED 186 mph*³

F-TYPE R



0-60MPH

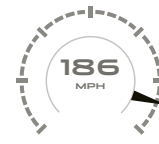

TOP SPEED MPH

5.0 LITER V8

SUPERCHARGED GAS [575HP] AWD
AUTOMATIC

MAXIMUM POWER 575HP

MAXIMUM TORQUE 516 lb-ft

ACCELERATION 0-60 mph 3.5 seconds*³

TOP SPEED 200 mph (Coupe only)*³

F-TYPE SVR



0-60MPH

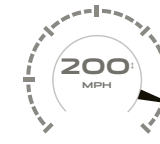

TOP SPEED MPH

*Coupe only.

2 CHOOSE YOUR MODEL & PACKAGES

 Configure your vehicle at jaguarusa.com



F-TYPE

KEY FEATURES

Active Sports Exhaust
Dynamic Mode
Deployable rear spoiler
LED headlights with signature DRL
LED tail lights
Infrared reflective windshield
Sport seats with leather and suedecloth facings
12-way electric front seats with memory
Leather steering wheel with gearshift paddles (automatic only)
Knurled Aluminum center console
SiriusXM® Radio*⁶ and HD Radio™
Meridian™ Sound System
Navigation Pro System*⁵
Rear Parking Aid*²
Rear View Camera*²
Torque Vectoring by Braking*²
Emergency Braking*^{2†}
Lane Departure Warning†

296HP & 340HP

Open Differential
18" alloy wheels
355mm front and 325mm rear brakes

380HP

Adaptive Dynamics*²
Limited Slip Differential*²
19" alloy wheels
380mm front and 325mm rear brakes with Black brake calipers
All Wheel Drive system*⁴ (optional)



F-TYPE R-DYNAMIC

KEY FEATURES (IN ADDITION TO F-TYPE)

Switchable Active Sports Exhaust
Design Package in Satin Dark Grey and Gloss Black
Delta Aluminum center console

380HP

Adaptive Dynamics*²
Limited Slip Differential
20" alloy wheels
380mm front and 325mm rear brakes with Black brake calipers
All Wheel Drive system*⁴ (optional)

*Please see page 116 for further information. †Feature introduced on the Jaguar F-TYPE model at mid model year. For information regarding the availability of this feature on your vehicle, please contact your authorized Jaguar Retailer.



F-TYPE R

KEY FEATURES (IN ADDITION TO F-TYPE 380HP)

550HP

- All Wheel Drive system*4
- 380mm front and 376mm rear brakes with Red brake calipers
- Electronic Active Differential
- Configurable Dynamic Mode
- 20" alloy wheels
- Bright metal pedals
- Premium leather interior
- R Performance seats with Windsor leather surface
- R branded leather steering wheel
- Linear Vee Aluminum center console with R branding
- Configurable Ambient Interior Lighting
- Wind deflector (Convertible only)
- Switchable Active Sport Exhaust
- Auto-dimming exterior mirrors
- Keyless Entry



F-TYPE SVR

KEY FEATURES (IN ADDITION TO F-TYPE R)

575HP

- Lightweight Titanium and Inconel® exhaust
- 20" Forged alloy wheels
- Redesigned aerodynamics
- Carbon Fiber rear aerodynamic spoiler
- SVR Performance seats with Lozenge quilted leather surface
- Suedecloth headlining
- Heated SVR branded leather steering wheel with aluminum gearshift paddles
- Dark Brushed Aluminum center console with SVR branding
- Front Parking Aid*2

2 CHOOSE YOUR MODEL & PACKAGES

 Configure your vehicle at jaguarusa.com

ROOF STYLES

F-TYPE offers a range of different roofs to suit your own personal style. Each delivering their own distinctive characteristics, they provide a powerful expression of individual flair both inside the cabin and to the outside world.



ALUMINUM ROOF

For the pure Coupe look, the F-TYPE aluminum roof is as strong and lightweight as the rest of the vehicle. It provides the ideal complement in color, style and line to the powerful F-TYPE profile. The aluminum roof expresses the F-TYPE in its clearest sports car form.



PANORAMIC GLASS ROOF

Introducing even more natural light and airiness to the interior, a full width panoramic glass roof is optional on F-TYPE Coupe models. For increased seclusion, should it be required, the roof features a manually sliding 'black-out' blind, which can screen the occupants from up to 99 percent of the incoming light.



CARBON FIBER ROOF

With Carbon Fiber outer and inner panels bonded together to create a strong yet light roof structure. It features Carbon Fiber weave visible through a deep, high-grade lacquered finish.



FABRIC ROOF

The lightweight fabric roof on the F-TYPE Convertible is available in a choice of four colors. Acoustically enhanced with composite fabric to reduce noise, it features a flush fitting heated glass rear window. The roof can be raised or lowered in just 12 seconds and operated fully automatically at speeds of up to 30 mph*³.

VEHICLES SHOWN: F-TYPE R IN YULONG WHITE WITH OPTIONAL EQUIPMENT

CONVERTIBLE ROOF COLORS

STANDARD

Black

OPTIONAL

Grey

Red

Beige

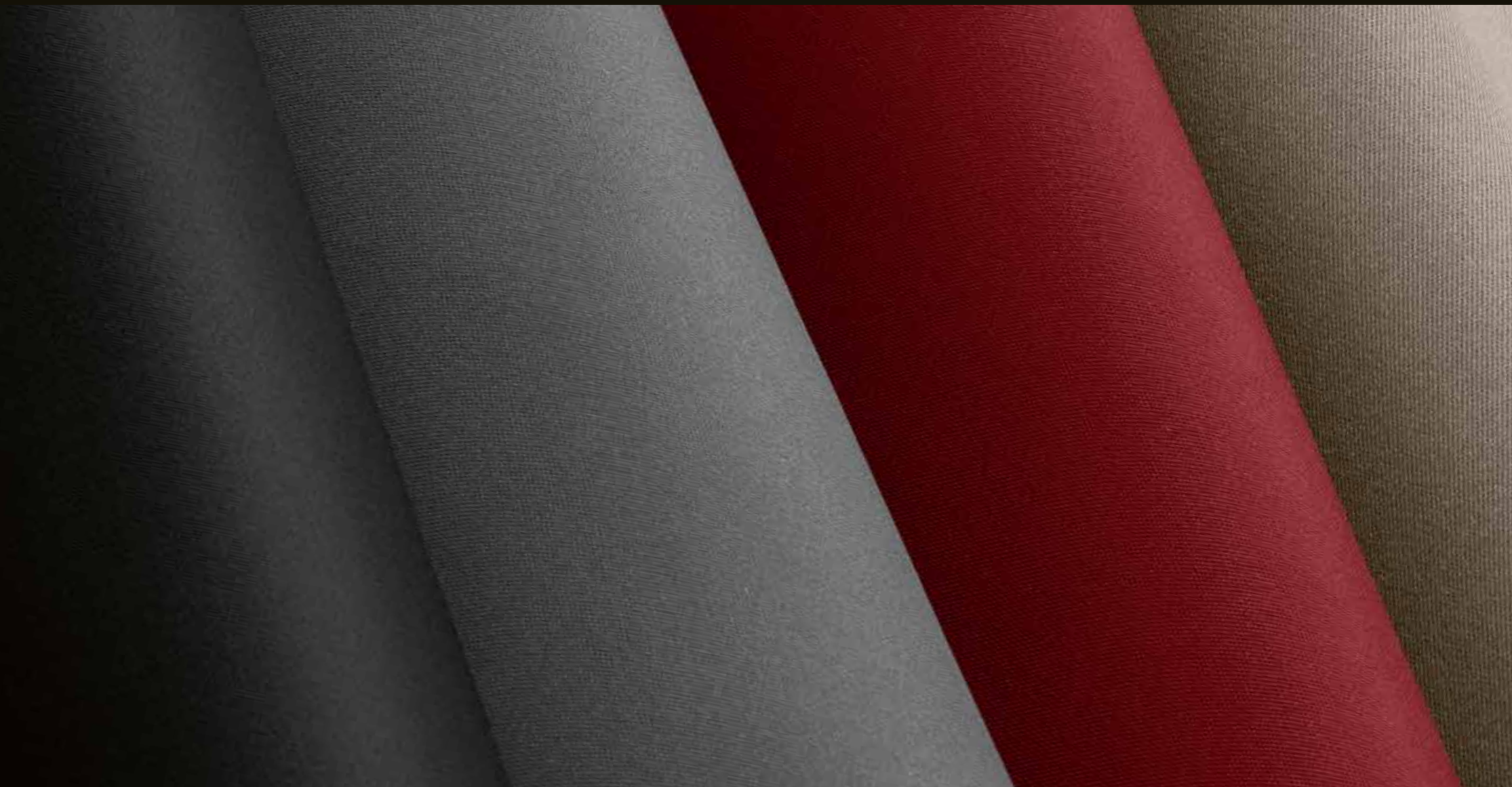

2 CHOOSE YOUR MODEL & PACKAGES

 Configure your vehicle at jaguarusa.com

KEY STANDARD FEATURES	F-TYPE	F-TYPE R-DYNAMIC	F-TYPE R	F-TYPE SVR	DESCRIPTION
	Rain, Ice, Snow Mode* ²	●	●	●	
Dynamic Stability Control (DSC)* ²	●	●	●	●	
Airbags* ⁸	●	●	●	●	4 airbags in the Convertible model, 6 airbags in the Coupe model
Electric Parking Brake (EPB)* ²	●	●	●	●	
Emergency Brake Assist* ²	●	●	●	●	
Anti-lock Braking System (ABS)	●	●	●	●	
Electronic Brake-force Distribution (EBD)* ²	●	●	●	●	
Flush exterior door handles	●	●	●	●	
Body-colored door mirror caps	●	●	●	●	
Rain sensing windshield wipers	●	●	●	●	
Deployable front air vents	●	●	●	●	
ClearSight interior rear view mirror	●	●	●	●	
Overhead lighting console	●	●	●	●	
Twin front cupholders	●	●	●	●	
8" Touchscreen* ¹	●	●	●	●	
Power socket	●	●	●	●	
USB and 12V socket in center console	●	●	●	●	
Remote central locking with deadlocks and drive-away locking	●	●	●	●	
Perimetric alarm and immobilizer	●	●	●	●	
Trunk entrapment release lever	●	●	●	●	
Push Button Start	●	●	●	●	
Valet Mode	●	●	●	●	
Emergency Braking (1)	●	●	●	●	
Lane Departure Warning (1)	●	●	●	●	
LED headlights	●	●	●	●	

● Standard ○ Option — Not available ■ Part of Package

*Please see page 116 for further information.

(1) Feature introduced on the Jaguar F-TYPE model at mid model year. For information regarding the availability of this feature on your vehicle, please contact your authorized Jaguar Retailer.

KEY OPTIONAL FEATURES

		F-TYPE (296HP & 340HP)	F-TYPE (380HP)	F-TYPE R-DYNAMIC (380HP)	F-TYPE R (550HP)	F-TYPE SVR (575HP)	
TRANSMISSION AND DYNAMIC FEATURES							
Carbon Fiber manual gearshift	C72J	○	—	○	—	—	Only available with manual transmission
Silver gearshift paddles	B66E	●	●	●	●	—	Only available with automatic transmission
Aluminum gearshift paddles	B66F	—	—	—	—	●	Only available with automatic transmission
Adaptive Dynamics* ²	C35A	—	●	●	●	●	
Dynamic Mode* ²	B73J	●	●	●	—	—	
Configurable Dynamic Mode* ²	B73K	—	○	○	●	●	
Open Differential	C37E	●	—	—	—	—	
Limited Slip Differential	C37F	—	●	●	—	—	
Electronic Active Differential	C37D	—	—	—	●	●	
Active Sports Exhaust	S65B	●	●	—	—	—	
Switchable Active Exhaust	S65L	○	○	●	●	●	
BRAKES							
Red brake calipers	C10R	—	○	○	●	●	Only available as an option with 380mm front and 325mm rear brakes or 380mm front and 376mm rear brakes
Black brake calipers	C10Y	—	●	●	○	○	Only available as an option with 380mm front and 376mm rear brakes
Yellow brake calipers	C10P	—	■	■	■	■	Part of Carbon Ceramic Brake Package, only available with automatic transmission models
355mm front and 325mm rear brakes	G36F	●	—	—	—	—	
380mm front and 325mm rear brakes	G36N	—	●	●	—	—	Only available with Red brake calipers or Black brake calipers. Not available with 18" alloy wheels
380mm front and 376mm rear brakes	G36M	—	○	○	●	●	Only available with Red brake calipers or Black brake calipers. Not available with 18" alloy wheels
398mm front and 380mm rear carbon ceramic brakes	G36P	—	■	■	■	■	Part of Carbon Ceramic Brake Package, only available with automatic transmission

2 CHOOSE YOUR MODEL & PACKAGES

 Configure your vehicle at jaguarusa.com

EXTERIOR FEATURES AND FINISHERS

EXTERIOR FEATURES AND FINISHERS	CODE	F-TYPE	F-TYPE R-DYNAMIC	F-TYPE R	F-TYPE SVR	DESCRIPTION
Black fully electric convertible roof	LPDE	●	●	●	●	Only available on Convertible
Grey fully electric convertible roof	LLKB	○	○	○	○	Only available on Convertible
Red fully electric convertible roof	LCHH	○	○	○	○	Only available on Convertible
Beige fully electric convertible roof	LSAL	○	○	○	○	Only available on Convertible
Gloss Black roll over protection bars	B67B	■	■	■	●	Only available on Convertible. Part of Black Exterior Package
Satin Chrome roll over protection bars	B67C	●	●	●	—	Only available on Convertible
Carbon Fiber roof	F45B	○	○	○	○	Only available on Coupe
Panoramic glass roof	F45A	○	○	○	○	Only available on Coupe
Powered tailgate	B69B	○	○	○	○	Only available on Coupe
Deployable rear spoiler	B09M/B09L	●	●	●	○	Reduces top speed of F-TYPE SVR to 186mph when selected
Fixed rear spoiler	B09F	○	○	○	—	Only available on Coupe. Requires Switchable Active Exhaust
Carbon Fiber rear aerodynamic spoiler	B09C/B09P	—	—	—	●	

GLASS AND EXTERIOR MIRRORS

Heated windshield	D96A	■	■	■	■	Part of Climate Package 1 or Climate Package 2
Power fold, heated door mirrors with memory	B28V	●	●	—	—	
Auto-dimming, power fold, heated door mirrors with memory	B28T	○	○	●	●	
Infrared reflective windshield	D97B	●	●	●	●	

HEADLIGHTS AND LIGHTING

LED headlights with signature DRL	D90R	●	●	●	●	
Auto High Beam Assist (AHBA)*2	D91A	○	○	○	○	
LED tail lights		●	●	●	●	

EXTERIOR COLORS

Solid paint		●	●	●	●	
Metallic paint		○	○	○	○	
Premium metallic paint		○	○	○	—	

WHEELS

Reduced section alloy spare wheel	C40D	○	○	○	○	Not available with Carbon Ceramic Brake Package
Tire Repair System	C40S	●	●	●	●	

INTERIOR SEATING

SEATING	CODE	F-TYPE	F-TYPE R-DYNAMIC	F-TYPE R	F-TYPE SVR	DESCRIPTION
Sport seats	B55A	●	●	—	—	
Performance seats	B55C	○	○	■	—	Linked to Premium Leather Interior Package, Suedecloth Interior Package or Full Premium Leather Interior Package on F-TYPE and F-TYPE R-Dynamic. R embossing is removed on F-TYPE R with Suedecloth Interior Package and Full Premium Leather Interior Package
R Performance seats	B55D	—	—	●	—	
SVR Performance seats	B55H	—	—	—	●	
Grained leather and suedecloth seats	B40N	●	●	—	—	
Windsor leather seats	B41H	■	■	●	—	Part of Premium Leather Interior Package
Suedecloth and Windsor leather seats with contrast stitching	B41J	■	■	■	—	Part of Suedecloth Interior Package. Not available on F-TYPE 296HP or 340HP
Lozenge quilted leather	B41U	—	—	—	●	
Red seat belts	RCHX	○	○	○	○	Red seat belts can be fitted to Ebony seats with Ebony or Pimento stitching, or Pimento seats
12-way electric front seats with memory	H53D	●	●	●	●	
Heated front seats	F53A	■	■	■	—	Only available with Sport seats or suedecloth Performance seats. Part of Climate Package 1
Heated and cooled front seats	F53F	■	■	■	■	Only available with Performance seats. Not available on suedecloth seats. Part of Climate Package 2

HEADLINING

HEADLINING						Refer to Page 90-91 for full details on interior color availability
Leather headlining	H01C	■	■	■	■	Part of Extended Leather Package
Suedecloth headlining	H01D	■	■	■	●	Part of Suedecloth Upper Environment Package and Suedecloth Interior Package. Not available on F-TYPE 296HP or 340HP
Morzine headlining	H01E	●	●	●	—	
Ebony headlining	HPDB	●	●	●	●	
Grey headlining	HLFZ	○	○	○	—	
Pimento headlining	HCHX	○	○	○	○	Not available on Coupe. Leather Only
Ivory headlining	HNAA	○	○	○	—	Not available with panoramic glass roof. Leather Only

● Standard ○ Option — Not available ■ Part of Package

*Please see page 116 for further information.

2 CHOOSE YOUR MODEL & PACKAGES

 Configure your vehicle at jaguarusa.com

INTERIOR FEATURES

INTERIOR FEATURES	CODE	F-TYPE	F-TYPE R-DYNAMIC	F-TYPE R	F-TYPE SVR	DESCRIPTION
Sunvisors with vanity mirrors	F57C	●	●	●	—	Only available in Ebony or Grey
Suede cloth sunvisors with vanity mirrors	F57G	■	■	■	●	Part of Suede cloth Upper Environment Package and Suede cloth Interior Package. Not available on F-TYPE 296HP or 340HP
Leather sunvisors with vanity mirrors	F57A	■	■	■	■	Part of Extended Leather Package
Bright metal pedals	G48S	○	○	●	●	Only available with automatic transmissions. Not available on F-TYPE 296HP or 340HP
Wind deflector	B74A	○	○	●	●	Only available on Convertible
Electrically adjustable steering column with memory	D07F	●	●	●	●	
Leather steering wheel	F95Y	●	●	—	—	
Flat-bottom leather steering wheel	F96V	○	○	—	—	
Flat-bottom leather steering wheel with Black spokes	F96S	■	■	—	—	Part of Interior Black Package
R branded leather steering wheel	F96L	—	—	●	—	
R branded flat-bottom leather steering wheel	F95R	—	—	○	—	
R branded flat-bottom leather steering wheel with Black spokes	F96U	—	—	■	—	Part of Interior Black Package
SVR branded leather steering wheel	F96Q	—	—	—	●	
SVR branded suede cloth steering wheel	F96P	—	—	—	○	Not available with heated steering wheel
Heated steering wheel	F97A	■	■	■	●	Part of Climate Packages
Premium carpet mats	H69R	●	●	—	—	
Sport carpet mats	H69L	○	○	—	—	Not available on F-TYPE 296HP or 340HP
Nubuck edged carpet mats	H69N	—	—	—	●	
Contrast carpet mats	H69V	■	■	●	—	Part of Full Premium Leather Interior Package. Not available on F-TYPE 296HP or 340HP

● Standard ○ Option — Not available ■ Part of Package

*Please see page 116 for further information.

INTERIOR FEATURES [CONTINUED]	CODE	F-TYPE	F-TYPE R-DYNAMIC	F-TYPE R	F-TYPE SVR	DESCRIPTION
Single-zone Climate Control	C88J	●	●	●	●	
Two-zone Climate Control	C88H	■	■	■	■	Part of Climate Package 1 or Climate Package 2
Air Quality Sensor	C89A	○	○	○	○	
Configurable Ambient Interior Lighting	B65D	○	○	●	●	
Illuminated metal treadplates with Jaguar script	F28F	○	○	○	○	

DRIVER ASSISTANCE AND SECURITY

DRIVER ASSISTANCE AND SECURITY	CODE	F-TYPE	F-TYPE R-DYNAMIC	F-TYPE R	F-TYPE SVR	DESCRIPTION
Garage door opener (HomeLink*)	B39N	○	○	○	○	
Keyless Entry	F04B	○	○	●	●	
Tire Pressure Monitoring System (TPMS)	C42R	●	●	●	●	
Blind Spot Monitor and Reverse Traffic Detection*2	H71C	■	■	■	■	Part of Drive Package
Rear View Camera*2	C14A	●	●	●	●	
Cruise Control and Speed Limiter*2	H41C	●	●	●	●	
Front Parking Aid*2	C13A	○	○	○	●	
Rear Parking Aid*2	C11A	●	●	●	●	
Park Assist*2	C18A	○	○	○	○	Requires Front Parking Aid. Not available on F-TYPE 296HP or 340HP
Emergency Braking*2†	H46W	●	●	●	●	
Lane Departure Warning*2†	H72C	●	●	●	●	
Lane Keep Assist*2†	H72F	■	■	■	■	Part of Drive Package
Driver Condition Monitor*2†	C59A	■	■	■	■	Part of Drive Package
Traffic Sign Recognition and Adaptive Speed Limiter*2†	A41B	■	■	■	■	Part of Drive Package

*Feature introduced on the Jaguar F-TYPE model at mid model year. For information regarding the availability of this feature on your vehicle, please contact your authorized Jaguar Retailer.

2 CHOOSE YOUR MODEL & PACKAGES

 Configure your vehicle at jaguarusa.com

INFORMATION, COMMUNICATION AND ENTERTAINMENT

INFORMATION AND COMMUNICATION	CODE	F-TYPE	F-TYPE R-DYNAMIC	F-TYPE R	F-TYPE SVR	DESCRIPTION
Protect™ *5	D45D	●	●	●	●	SOS Emergency Call, Jaguar Optimized Assistance, and Stolen Vehicle Locator. Service complimentary for 5 years
Remote™ *5	D47A	●	●	●	●	Smartphone application for vehicle status (fuel level, security status, last parked, direction to vehicle), vehicle lock/unlock, A/C remote setting through engine start. Feature complimentary for 5 years
InControl Apps™ *5	H57A	●	●	●	●	Enables use of optimized 3rd party smartphone apps installed on a phone through the vehicle's Touchscreen*5
Touch Pro™ *5 System	G64D	●	●	●	●	
Navigation Pro System*5	G50H	●	●	●	●	Navigation system with 60GB Solid State Disk (SSD) drive-based mapping
Pro Services™ *5	A44J	●	●	●	●	
Bluetooth® connectivity*1	H74V	●	●	●	●	
5" central TFT display with instrument panel - 190 mph	P50R	●	●	—	—	
5" central TFT display with instrument panel - 210 mph	P50Q	—	—	●	●	

AUDIO

Sirius XM® Satellite Radio*6† and HD Radio™	B51D	●	●	●	●	
Meridian™ Sound System (380W)	B44V	●	●	●	●	
Meridian™ Surround Sound System (770W)	B43U	○	○	○	○	

● Standard ○ Option — Not available ■ Part of Package

*Please see page 116 for further information.

OPTION PACKAGES

	CODE	F-TYPE	F-TYPE R-DYNAMIC	F-TYPE R	F-TYPE SVR	DESCRIPTION
Black Exterior Package	Z93L	○	○	○	—	Gloss Black finish to side window surrounds (Coupe only), front bumper splitter, front grille surround, side power vents, hood louvers, rear valance and roll over protection bars (Convertible only)*
Exterior Design Package	Z93M	—	○	○	—	Body colored front bumper splitter, side sills and rear venturi*
Exterior Black Design Package	Z93N	—	○	○	—	Body-colored front bumper splitter, side sills and rear venturi. Gloss Black finish to side window surrounds (Coupe only), front grille surround, side power vents, hood louvers and roll over protection bars (Convertible only)*
Exterior Carbon Fiber Package	Z94K	—	○	○	—	Body-colored front bumper splitter, side sills and rear venturi. Gloss Black finish to side window surrounds (Coupe only) and front grille surround. Carbon Fiber side power vents, hood louvers, mirror caps and roll over protection bars (Convertible only)*
Exterior Carbon Fiber Package SVR	Z94I	—	—	—	○	Carbon Fiber side power vents, hood louvers, mirror caps, front bumper splitter, rear venturi blade and roll over protection bars (Convertible only)
Carbon Ceramic Brake Package with 20" alloy wheels	Z73N	○	○	○	—	Yellow brake calipers, 20" 5 split-spoke 'Style 5040' alloy wheels with metallic Black finish, 398mm front and 380mm rear carbon ceramic brakes, Bright metal pedals (standard on R). Requires 380HP automatic or F-TYPE R
Carbon Ceramic Brake Package with SVR Forged alloy wheels	Z73R	—	—	—	○	Yellow brake calipers, 20" 10 spoke 'Style 1041' Forged alloy wheels with Satin Black Diamond Turned finish, 398mm front and 380mm rear carbon ceramic brakes
Extended Leather Package	Z23C	○	○	○	○	Leather sunvisors with vanity mirrors, leather headlining**
Suede cloth Upper Environment Package	Z23D	○	○	○	—	Suede cloth sunvisors with vanity mirrors, suede cloth headlining. Not available on F-TYPE 296HP or 340HP
Climate Package 1	Z88K	○	○	○	—	Two-zone Climate Control, heated windshield, heated front seats, heated steering wheel
Climate Package 2	Z88L	○	○	○	○	Two-zone Climate Control, heated windshield, heated and cooled front seats, heated steering wheel
Premium Leather Interior Package	Z84M	○	○	—	—	Premium leather door trim, Windsor leather seats, console and instrument panel topper
Full Premium Leather Interior Package†	Z84T	○	○	○	○	Premium leather with twin stitching on door trim, console and instrument panel topper, contrast carpet mats (standard on R and SVR). Not available on F-TYPE 296HP or 340HP
Suede cloth Interior Package	TP22	○	○	○	—	Suede cloth door trim, suede cloth and Windsor leather seats with contrast stitching, Performance seats, suede cloth sunvisors with vanity mirrors, suede cloth headlining, premium leather console with twin stitching, suede cloth wrapped instrument panel topper with contrast stitching. Not available on F-TYPE 296HP or 340HP
Interior Black Package	Z01P	○	○	○	—	Black vent surrounds, Gloss Black instrument cluster dial rings, Gloss Black door release and flat-bottom leather steering wheel with Black spokes. (R branded on F-TYPE R)
Drive Package	Z79B	○	○	○	○	Traffic Sign Recognition and Adaptive Speed Limiter, Blind Spot Monitor and Reverse Traffic Detection, Driver Condition Monitor, Lane Keep Assist

*Package content varies between models. **Vehicle must have Premium Leather Interior Package or Full Premium Leather Interior Package.

†Performance seats only. Only available in Pimento and Sienna Tan full premium leather interiors. R embossing is removed on F-TYPE R.

Refer to Page 90-91 for full details on interior color availability when selecting an Interior Package.

3 CHOOSE YOUR COLOR

 [Configure your vehicle at jaguarusa.com](https://www.jaguarusa.com)

SOLID

Narvik Black

Fuji White

Caldera Red

METALLIC

Santorini Black

Yulong White

Corris Grey



PREMIUM

Indus Silver



British Racing Green



Loire Blue



Ultra Blue



Carpathian Grey



Silicon Silver



4 CHOOSE YOUR WHEELS AND BRAKING SYSTEM

 Configure your vehicle at jaguar.com



18" 10 SPOKE
'STYLE 1036'



18" 10 SPOKE
'STYLE 1024'



19" 10 SPOKE
'STYLE 1023'



19" 7 SPLIT-SPOKE
'STYLE 7013'

ALLOY WHEEL FINISH	Silver	Silver	Silver	Silver
FRONT ALLOY WHEELS	8.5J x 18"	8.5J x 18"	8.5J x 19"	8.5J x 19"
FRONT TIRES	245/45 R18	245/45 R18	245/40 R19	245/40 R19
REAR ALLOY WHEELS	9.5J x 18"	9.5J x 18"	9.5J x 19"	9.5J x 19"
REAR TIRES	275/40 R18	275/40 R18	275/35 R19	275/35 R19
CODE	C55A	C51C	C51B	C51E
F-TYPE 296HP	●	—	○	○
F-TYPE 340HP	—	●	○	○
F-TYPE 380HP	—	—	●	○
F-TYPE R-Dynamic 380HP	—	—	—	—
F-TYPE R	—	—	—	—
F-TYPE SVR	—	—	—	—



355MM FRONT AND
325MM REAR BRAKES



380MM FRONT AND
325MM REAR BRAKES



380MM FRONT AND
376MM REAR BRAKES



398MM FRONT AND
380MM REAR CARBON
CERAMIC BRAKES

● Standard ○ Option — Not Applicable ■ Part of Package

*Automatic transmission only.

Please consult your local Jaguar Retailer for details. For a complete list of optional features and Packs refer to the F-TYPE Specification and Price Guide or configure your vehicle at jaguarusa.com



19" 5 SPLIT-SPOKE
'STYLE 5058'

20" 6 SPLIT-SPOKE
'STYLE 6003'

20" 5 SPOKE
'STYLE 5060'

20" 5 SPOKE
'STYLE 5042'

20" 5 SPLIT-SPOKE
'STYLE 5061'

20" 5 SPLIT-SPOKE
'STYLE 5040'

FORGED 20"
10 SPOKE 'STYLE 1041'

Technical Grey and Diamond Turned	Dark Grey and Diamond Turned	Silver	Carbon Fiber, Satin Grey and Diamond Turned	Satin Grey	Metallic Black	Satin Black and Diamond Turned
8.5J x 19"	9.0J x 20"	9.0J x 20"	9.0J x 20"	9.0J x 20"	9.0J x 20"	9.0J x 20"
245/40 R19	255/35 R20	255/35 R20	255/35 R20	265/35 R20	255/35 R20	265/35 R20
9.5J x 19"	10.5J x 20"	10.5J x 20"	10.5J x 20"	11.0J x 20"	10.5J x 20"	11.0J x 20"
275/35 R19	295/30 R20	295/30 R20	295/30 R20	305/30 R20	295/30 R20	305/30 R20
C50T	C52B	C55B	C51M	C55U	C53I	C55S
○	○	○	○	—	—	—
○	○	○	○	—	—	—
○	○	○	○	—	■*	—
—	●	○	○	—	■*	—
—	○	●	○	—	■	—
—	—	—	—	●	—	■

BRAKING SYSTEMS

	CODE	F-TYPE (296HPPS & 340HP)	F-TYPE (380HP)	F-TYPE R-DYNAMIC (380HP)	F-TYPE R (550HP)	F-TYPE SVR (575HP)	DESCRIPTION
355mm front and 325mm rear brakes	G36F	●	—	—	—	—	
380mm front and 325mm rear brakes	G36N	—	●	●	—	—	Only available with Red brake calipers or Black brake calipers. Not available with 18" wheels
380mm front and 376mm rear brakes	G36M	○	○	○	●	●	Only available with Red brake calipers or Black brake calipers. Not available with 18" wheels
398mm front and 380mm rear carbon ceramic brakes	G36P	—	■*	■*	■	■	Part of Carbon Ceramic Brake Pack with 20" alloy wheels and Carbon Ceramic Brake Pack with SVR Forged alloy wheels

5 CHOOSE YOUR INTERIOR

 Configure your vehicle at jaguarusa.com

F-TYPE AND F-TYPE R-DYNAMIC						
	SEAT WITH STITCH	UPPER FASCIA WITH STITCH	INTERIOR TRIM AND OPTION CODES	HEADLINING	CARPETS	SEAT BELTS
Standard						
Sport seats with leather and suedecloth facings	Ebony with Ebony	Ebony with Ebony	TP01	Ebony or Grey	Ebony	Ebony or Red
	Cirrus with Cirrus	Ebony with Ebony	TP04	Ebony or Grey	Ebony	Ebony
Optional						
Sport seats in premium leather and premium leather interior ¹	Ebony with Ebony	Ebony with Ebony	TP01+Z84M	Ebony, Grey or Ivory ³	Ebony	Ebony or Red
	Cirrus with Cirrus	Ebony with Ebony	TP04+Z84M	Ebony or Grey	Ebony	Ebony
Performance seats in premium leather and premium leather interior ¹	Ebony with Ebony	Ebony with Ebony	TP01+B55C+Z84M	Ebony, Grey or Ivory ³	Ebony	Ebony or Red
	Ebony with Pimento	Ebony with Ebony	TP05+B55C+Z84M	Ebony, Grey or Pimento ⁴	Ebony	Ebony or Red
	Ebony with Sienna Tan	Ebony with Ebony	TP33+B55C+Z84M	Ebony or Grey	Ebony	Ebony
	Ebony with Ivory	Ebony with Ebony	TP29+B55C+Z84M	Ebony, Grey or Ivory ³	Ebony	Ebony
	Sienna Tan with Cirrus	Ebony with Ebony	TP38+B55C+Z84M	Ebony or Grey	Ebony	Ebony
	Brogue with Ivory	Ebony with Ebony	TP11+B55C+Z84M	Ebony, Grey or Ivory ³	Ebony	Ebony
	Pimento with Ebony	Ebony with Ebony	TP12+B55C+Z84M	Ebony, Grey or Pimento ⁴	Ebony	Ebony or Red
	Ivory with Ebony	Ebony with Ebony	TP28+B55C+Z84M	Ebony, Grey or Ivory ³	Ebony	Ebony
Performance seats in premium leather and suedecloth and premium leather interior ^{1 5}	Ebony with Cirrus	Ebony with Cirrus	TP22+B55C	Ebony suedecloth	Ebony	Ebony
Performance seats in premium leather and extended leather upper fascia ^{2 5}	Pimento with Ebony	Pimento with Ebony	TP23+B55C	Ebony or Pimento ⁴	Ebony	Ebony or Red
	Sienna Tan with Cirrus	Sienna Tan with Cirrus	TP34+B55C	Ebony	Ebony	Ebony

¹Premium leather interior adds premium leather to the upper fascia, center console and door inserts.

²Includes colored premium leather passenger side upper fascia, upper door casings, center console and Ebony carpet mats with colored Nubuck edging and Ebony contrast stitching.

³Ivory leather headlining not available with panoramic glass roof.

⁴Pimento leather headlining available on Convertible only.

⁵Not available with F-TYPE 296HP or 340HP.

F-TYPE R						
	SEAT WITH STITCH	UPPER FASCIA WITH STITCH	INTERIOR TRIM AND OPTION CODES	HEADLINING	CARPETS	SEAT BELTS
Standard						
Performance seats in premium leather with R embossed headrests and premium leather interior	Ebony with Ebony	Ebony with Ebony	TP01	Ebony, Grey or Ivory ³	Ebony	Ebony or Red
	Ebony with Ivory	Ebony with Ivory	TP17	Ebony, Grey or Ivory ³	Ebony	Ebony
	Ebony with Pimento	Ebony with Pimento	TP24	Ebony, Grey or Pimento ⁴	Ebony	Ebony or Red
	Ebony with Sienna Tan	Ebony with Sienna Tan	TP36	Ebony or Grey	Ebony	Ebony
	Sienna Tan and Ebony duo tone with Sienna Tan	Ebony with Sienna Tan	TP37	Ebony or Grey	Ebony	Ebony
	Ivory and Ebony duo tone with Ivory	Ebony with Ivory	TP20	Ebony, Grey or Ivory ³	Ebony	Ebony
	Pimento and Ebony duo tone with Pimento	Ebony with Pimento	TP19	Ebony, Grey or Pimento ⁴	Ebony	Ebony or Red
Optional						
Performance seats in premium leather and suedecloth and premium leather interior	Ebony with Cirrus	Ebony with Cirrus	TP22	Ebony Suedecloth	Ebony	Ebony
Performance seats in premium leather and extended leather upper fascia ²	Pimento with Ebony	Pimento with Ebony	TP23	Ebony or Pimento ⁴	Ebony	Ebony or Red
	Sienna Tan with Cirrus	Sienna Tan with Cirrus	TP34	Ebony	Ebony	Ebony
F-TYPE SVR						
	SEAT WITH STITCH	UPPER FASCIA WITH STITCH	INTERIOR TRIM AND OPTION CODES	HEADLINING	CARPETS	SEAT BELTS
Standard						
Quilted Performance seats in premium leather with SVR embossed headrests and suedecloth driver's instrument panel area	Ebony with Cirrus	Ebony with Cirrus	TP31	Ebony	Ebony	Ebony
	Ebony with Pimento	Ebony with Pimento	TP24	Ebony or Pimento ⁴	Ebony	Ebony or Red
	Ebony with Reims Blue	Ebony with Reims Blue	TP32	Ebony	Ebony	Ebony
Optional						
Quilted Performance seats in premium leather with SVR embossed headrests and extended leather upper fascia ²	Pimento with Ebony	Pimento with Ebony	TP23	Ebony or Pimento ⁴	Ebony	Red
	Sienna Tan with Cirrus	Sienna Tan with Cirrus	TP34	Ebony	Ebony	Ebony

5 CHOOSE YOUR INTERIOR

Configure your vehicle at jaguarusa.com







Interior shown: F-TYPE R-Dynamic with optional Ebony premium leather Performance seats, Delta Aluminum finisher, Ebony morzine headlining, Ebony upper fascia and Ebony carpets.

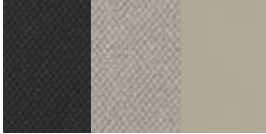

F-TYPE AND F-TYPE R-DYNAMIC

INTERIOR COLOR COMBINATIONS

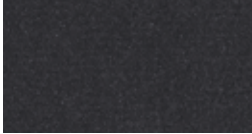
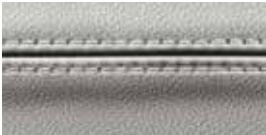
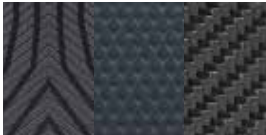
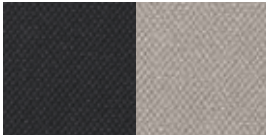
STANDARD SPORT SEATS WITH LEATHER AND SUEDECLOTH FACINGS
 OPTIONAL SPORT SEATS IN PREMIUM LEATHER AND PREMIUM LEATHER INTERIOR

①	②	③	④	⑤
SEAT WITH STITCH	FINISHER	HEADLINING*	UPPER FASCIA WITH STITCH	CARPET
				
Ebony with Ebony	Delta Aluminum [†] , Knurled Aluminum ^{††} , Carbon Fiber	Ebony, Grey or Ivory [‡]	Ebony with Ebony	Ebony
				
Cirrus with Cirrus	Delta Aluminum [†] , Knurled Aluminum ^{††} , Carbon Fiber	Ebony or Grey	Ebony with Ebony	Ebony

OPTIONAL PERFORMANCE SEATS IN PREMIUM LEATHER AND PREMIUM LEATHER INTERIOR

SEAT WITH STITCH	FINISHER	HEADLINING*	UPPER FASCIA WITH STITCH	CARPET
				
Ebony with Ebony	Delta Aluminum [†] , Knurled Aluminum ^{††} , Carbon Fiber	Ebony, Grey or Ivory [‡]	Ebony with Ebony	Ebony
				
Ebony with Pimento	Delta Aluminum [†] , Knurled Aluminum ^{††} , Carbon Fiber	Ebony, Grey or Pimento ^{**}	Ebony with Ebony	Ebony

*Ebony morzine standard, Grey morzine and Ebony suedecloth optional. Ebony, Pimento and Ivory leather optional.

**Pimento leather headlining only available on Convertible.

†Delta Aluminum is standard on F-TYPE R-Dynamic and not available on F-TYPE.













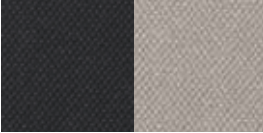

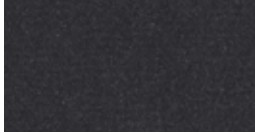

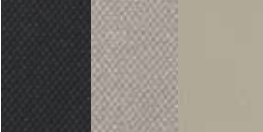

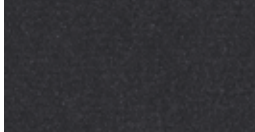

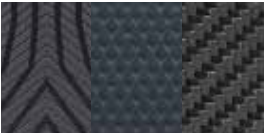
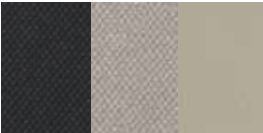
††Knurled Aluminum is standard on F-TYPE and optional on F-TYPE R-Dynamic.

‡Ivory leather headlining not available with panoramic glass roof.

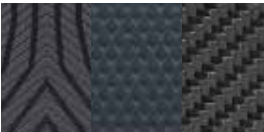
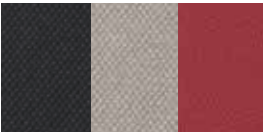
F-TYPE AND F-TYPE R-DYNAMIC

INTERIOR COLOR COMBINATIONS

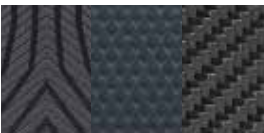
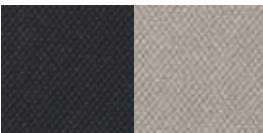
OPTIONAL PERFORMANCE SEATS IN PREMIUM LEATHER AND PREMIUM LEATHER INTERIOR [CONTINUED]

1	2	3	4	5
SEAT WITH STITCH	FINISHER	HEADLINING*	UPPER FASCIA WITH STITCH	CARPET
 Ebony with Sienna Tan	 Delta Aluminum [†] , Knurled Aluminum ^{††} , Carbon Fiber	 Ebony or Grey	 Ebony with Ebony	 Ebony
 Ebony with Ivory	 Delta Aluminum [†] , Knurled Aluminum ^{††} , Carbon Fiber	 Ebony, Grey or Ivory [‡]	 Ebony with Ebony	 Ebony
 Brogue with Ivory	 Delta Aluminum [†] , Knurled Aluminum ^{††} , Carbon Fiber	 Ebony, Grey or Ivory [‡]	 Ebony with Ebony	 Ebony
 Pimento with Ebony	 Delta Aluminum [†] , Knurled Aluminum ^{††} , Carbon Fiber	 Ebony, Grey or Pimento ^{**}	 Ebony with Ebony	 Ebony
 Sienna Tan with Cirrus	 Delta Aluminum [†] , Knurled Aluminum ^{††} , Carbon Fiber	 Ebony or Grey	 Ebony with Ebony	 Ebony

*Ebony morzine standard, Grey morzine and Ebony suedecloth optional. Ebony, Pimento and Ivory leather optional.

**Pimento leather headlining only available on Convertible.

†Delta Aluminum is standard on F-TYPE R-Dynamic and not available on F-TYPE.



††Knurled Aluminum is standard on F-TYPE and optional on F-TYPE R-Dynamic.

‡Ivory leather headlining not available with panoramic glass roof.

§Not available with F-TYPE 296HP or 340HP.

¶Not available with automatic transmission.

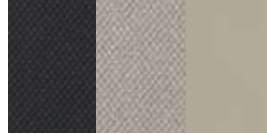

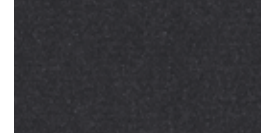





OPTIONAL PERFORMANCE SEATS IN PREMIUM LEATHER AND PREMIUM LEATHER INTERIOR [CONTINUED]

①	②	③	④	⑤
SEAT WITH STITCH	FINISHER	HEADLINING*	UPPER FASCIA WITH STITCH	CARPET
				
Ivory with Ebony	Delta Aluminum+, Knurled Aluminum++, Carbon Fiber	Ebony, Grey or Ivory+	Ebony with Ebony	Ebony

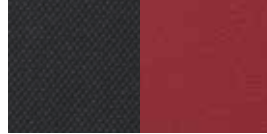
OPTIONAL PERFORMANCE SEATS IN PREMIUM LEATHER AND SUEDECLOTH AND PREMIUM LEATHER INTERIOR¹

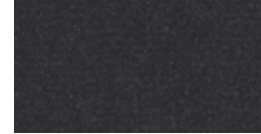
SEAT WITH STITCH	FINISHER	HEADLINING	UPPER FASCIA WITH STITCH	CARPET
				
Ebony with Cirrus	Delta Aluminum+, Knurled Aluminum++, Carbon Fiber	Ebony suedecloth	Ebony with Cirrus	Ebony

OPTIONAL PERFORMANCE SEATS IN PREMIUM LEATHER AND EXTENDED PREMIUM LEATHER INTERIOR¹

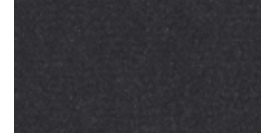
SEAT WITH STITCH	FINISHER	HEADLINING*	UPPER FASCIA WITH STITCH	CARPET
				
Pimento with Ebony	Delta Aluminum+, Knurled Aluminum++, Carbon Fiber	Ebony or Pimento**	Pimento with Ebony	Ebony
				
Sienna Tan with Cirrus ²	Delta Aluminum+, Knurled Aluminum++, Carbon Fiber	Ebony	Sienna Tan with Cirrus	Ebony

5 CHOOSE YOUR INTERIOR

Configure your vehicle at jaguarusa.com













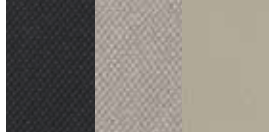

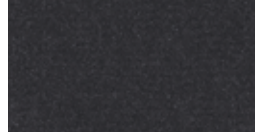
Interior shown: F-TYPE R with optional Pimento premium leather Performance seats, Linear Vee Aluminum finisher, Ebony leather headlining, Pimento upper fascia and Ebony carpets.

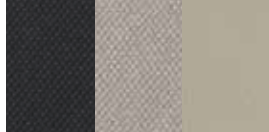

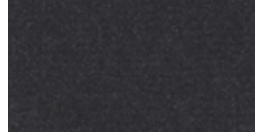
F-TYPE R

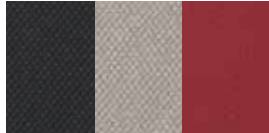
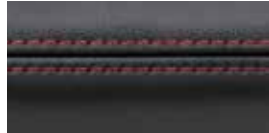
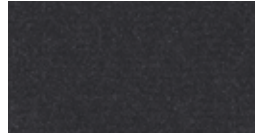
INTERIOR COLOR COMBINATIONS

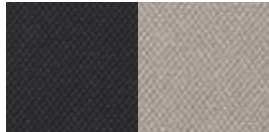
STANDARD R-PERFORMANCE SEATS IN PREMIUM LEATHER AND PREMIUM LEATHER INTERIOR

1	2	3	4	5
SEAT WITH STITCH	FINISHER	HEADLINING*	UPPER FASCIA WITH STITCH	CARPET
 Ebony with Ebony	 Linear Vee Aluminum†, Knurled Aluminum, Carbon Fiber	 Ebony, Grey or Ivory**	 Ebony with Ebony	 Ebony
 Ebony with Ivory	 Linear Vee Aluminum†, Knurled Aluminum, Carbon Fiber	 Ebony, Grey or Ivory**	 Ebony with Ivory	 Ebony
 Ebony with Pimento	 Linear Vee Aluminum†, Knurled Aluminum, Carbon Fiber	 Ebony, Grey or Pimento**	 Ebony with Pimento	 Ebony
 Ebony with Sienna Tan	 Linear Vee Aluminum†, Knurled Aluminum, Carbon Fiber	 Ebony or Grey	 Ebony with Sienna Tan	 Ebony

*Ebony morzine standard, Grey morzine and Ebony suedecloth optional. Ebony, Pimento and Ivory leather optional.

**Pimento leather headlining only available on Convertible.











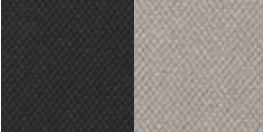

†Linear Vee Aluminum is standard.

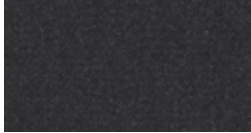
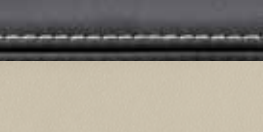
**Ivory leather headlining not available with panoramic glass roof.

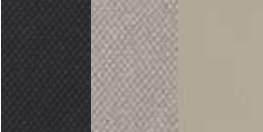
F-TYPE R

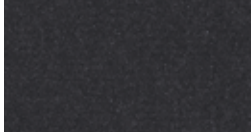
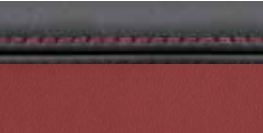
INTERIOR COLOR COMBINATIONS

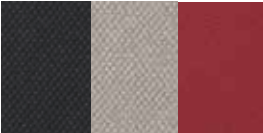
STANDARD R-PERFORMANCE SEATS IN PREMIUM LEATHER AND PREMIUM LEATHER INTERIOR [CONTINUED]

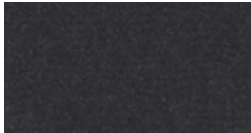
1	2	3	4	5
DUO TONE SEAT WITH STITCH	FINISHER	HEADLINING*	UPPER FASCIA WITH STITCH	CARPET
				
Ebony with Sienna Tan	Linear Vee Aluminum†, Knurled Aluminum, Carbon Fiber	Ebony or Grey	Ebony with Sienna Tan	Ebony
				
Ebony with Ivory	Linear Vee Aluminum†, Knurled Aluminum, Carbon Fiber	Ebony, Grey or Ivory††	Ebony with Ivory	Ebony
				
Ebony with Pimento	Linear Vee Aluminum†, Knurled Aluminum, Carbon Fiber	Ebony, Grey or Pimento**	Ebony with Pimento	Ebony

*Ebony morzine standard. Grey morzine and Ebony suedecloth optional. Ebony, Pimento and Ivory leather optional.

**Pimento leather headlining only available on Convertible.









†Linear Vee Aluminum is standard.

††Ivory leather headlining not available with panoramic glass roof.

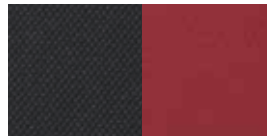
OPTIONAL R-PERFORMANCE SEATS IN PREMIUM LEATHER AND SUEDECLOTH
AND PREMIUM LEATHER INTERIOR

①	②	③	④	⑤
SEAT WITH STITCH	FINISHER	HEADLINING*	UPPER FASCIA WITH STITCH	CARPET
				
Ebony with Cirrus	Linear Vee Aluminum†, Knurled Aluminum, Carbon Fiber	Ebony suedecloth	Ebony with Cirrus	Ebony

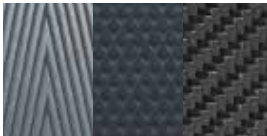
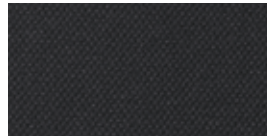
OPTIONAL R-PERFORMANCE SEATS IN PREMIUM LEATHER AND EXTENDED PREMIUM LEATHER INTERIOR

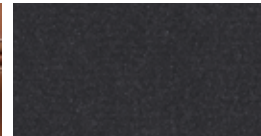
SEAT WITH STITCH	FINISHER	HEADLINING*	UPPER FASCIA WITH STITCH	CARPET
				
Pimento with Ebony	Linear Vee Aluminum†, Knurled Aluminum, Carbon Fiber	Ebony or Pimento**	Pimento with Ebony	Ebony
				
Sienna Tan with Cirrus	Linear Vee Aluminum†, Knurled Aluminum††, Carbon Fiber	Ebony	Sienna Tan with Cirrus	Ebony

5 CHOOSE YOUR INTERIOR

 Configure your vehicle at jaguarusa.com









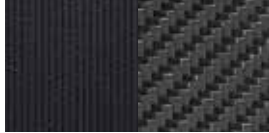

Interior shown: F-TYPE SVR Ebony quilted premium leather Performance seats with Cirrus stitch and micropiping, Dark Brushed Aluminum finisher, Ebony headlining, Ebony upper fascia and Ebony carpets.

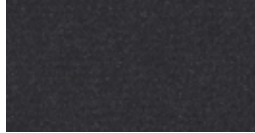



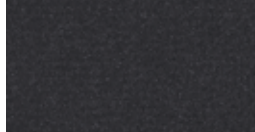

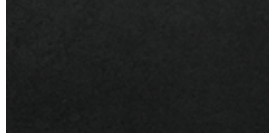

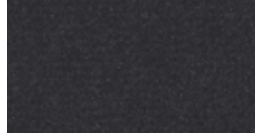

F-TYPE SVR

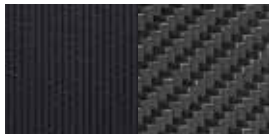
INTERIOR COLOR COMBINATIONS

STANDARD SVR QUILTED PREMIUM LEATHER PERFORMANCE SEATS WITH PREMIUM LEATHER AND SUEDECLOTH INTERIOR

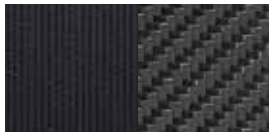
1	2	3	4	5
SEAT WITH STITCH	FINISHER	HEADLINING*	UPPER FASCIA WITH STITCH	CARPET
				
Ebony with Cirrus	Dark Brushed Aluminum† or Carbon Fiber	Ebony	Ebony with Cirrus	Ebony
				
Ebony with Pimento	Dark Brushed Aluminum† or Carbon Fiber	Ebony or Pimento**	Ebony with Pimento	Ebony
				
Ebony with Reims Blue	Dark Brushed Aluminum† or Carbon Fiber	Ebony	Ebony with Reims Blue	Ebony

OPTIONAL SVR QUILTED PREMIUM LEATHER PERFORMANCE SEATS WITH PREMIUM LEATHER INTERIOR

SEAT WITH STITCH	FINISHER	HEADLINING*	UPPER FASCIA WITH STITCH	CARPET
				
Pimento with Ebony	Dark Brushed Aluminum† or Carbon Fiber	Ebony or Pimento**	Pimento with Ebony	Ebony
				
Sienna Tan with Cirrus	Dark Brushed Aluminum† or Carbon Fiber	Ebony	Sienna Tan with Cirrus	Ebony

*Ebony suedecloth standard. Ebony and Pimento leather optional.

**Pimento leather headlining only available on Convertible.

†Dark Brushed Aluminum is standard.

5 CHOOSE YOUR INTERIOR

 Configure your vehicle at jaguarusa.com

Knurled Aluminum Center Console

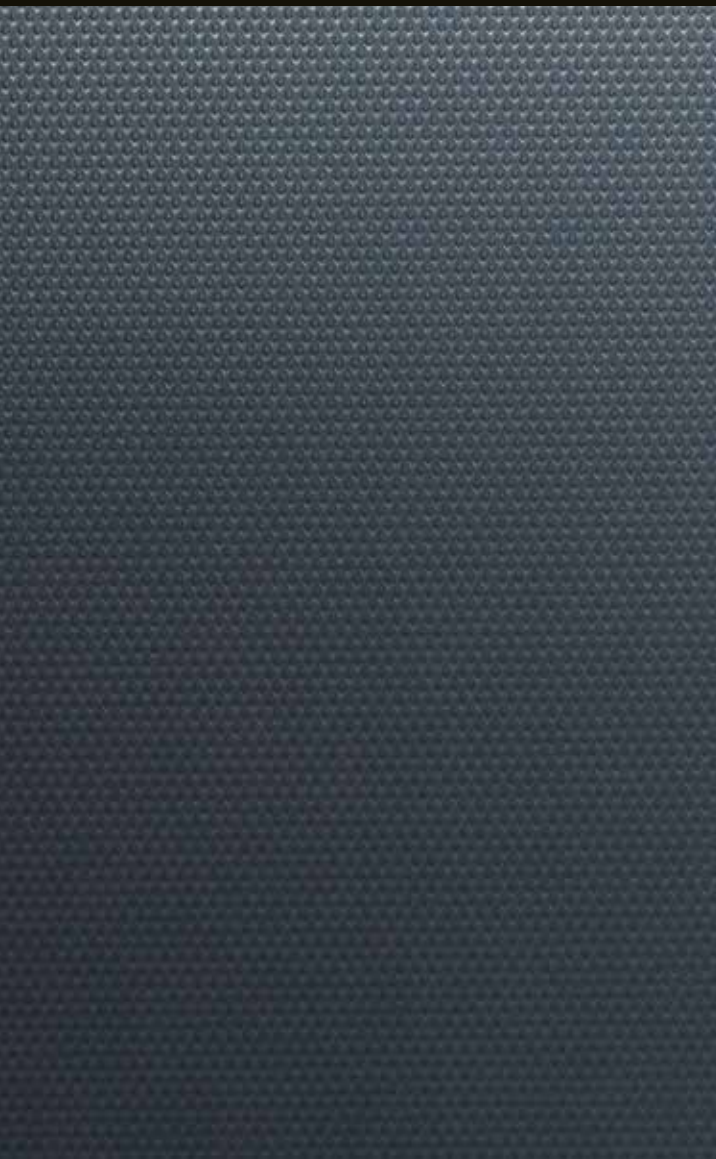

Delta Aluminum Center Console

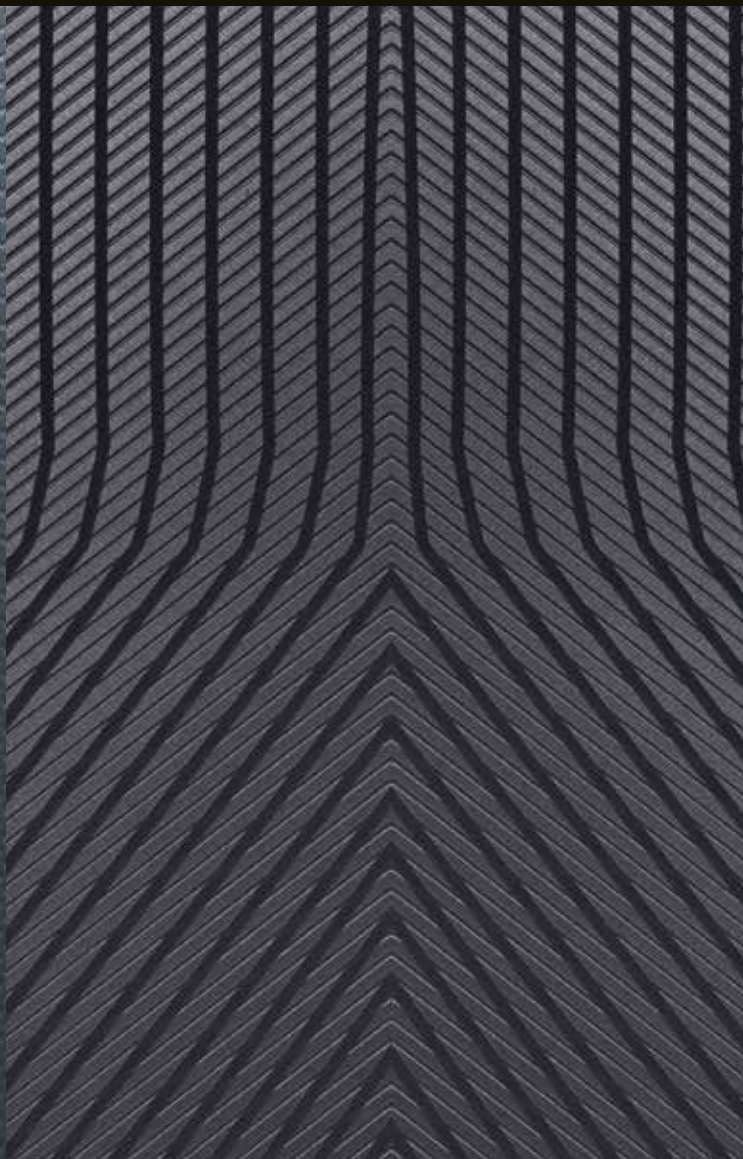

Linear Vee Aluminum Center Console with R Branding



Carbon Fiber Center Console

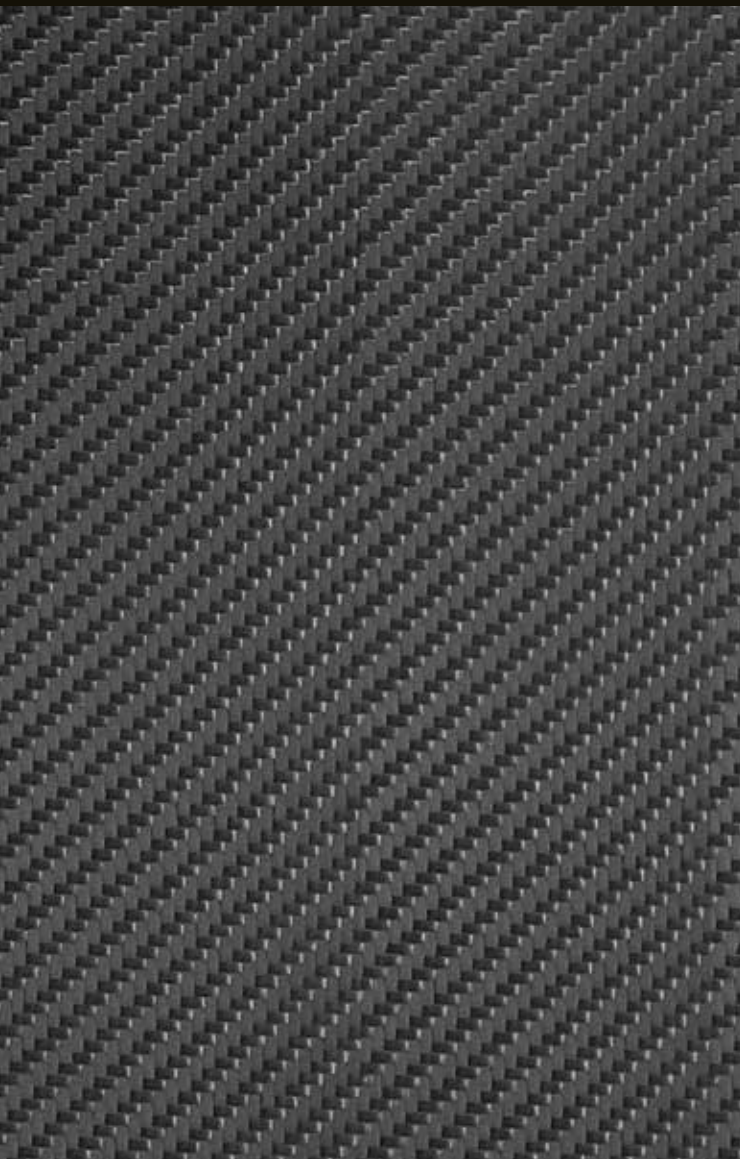

Dark Brushed Aluminum Center Console with SVR Branding



Carbon Fiber Center Console with SVR Branding



6 CHOOSE YOUR JAGUAR GEAR ACCESSORIES

To find out more about the full range of retailer fit Jaguar Gear Accessories, please refer to your retailer or go to jaguarusa.com/accessories



VEHICLE SHOWN: F-TYPE R IN YULONG WHITE WITH SILVER WEAVE CARBON FIBER PACKAGE



Carbon Fiber Gear Selector*
T2R24247

Enjoy the unique feel of this performance-inspired Carbon Fiber topped gear selector with a High Gloss lacquered finish.



Personalized Illuminated Sill Treadplates
T2R6091

Elegantly styled stainless steel sill treadplate finisher for driver or passenger doors. Illuminate when either the driver or passenger doors are opened. Highlighted by soft Phosphor Blue lighting. Allows you to specify a monochrome 'motif' in a choice of approved typefaces/scripts.



Aluminum Gearshift Paddles**
T2R6547MMU

Replacement steering wheel gearshift paddles offered in a premium aluminum material providing a high quality finish to a key contact point in the vehicle. Manufactured from billet machined aluminum, the paddles are hand brushed for a premium finish and anodized to ensure they will not deteriorate with wear.



Flexible Luggage Retainer
C2D20903

Provides a neat storage solution to help secure luggage or other items within the luggage compartment.



Luxury Carpet Mats
T2R16570PVJ

Luxurious, tailored 2,050g/m² pile front carpet mats with embossed Jaguar logo and Nubuck edge binding. The luxury mats provide a well appointed finishing touch to the interior.



Side Net†
T2R22934

Side net provides additional enclosed storage in the luggage compartment and helps to secure loose items such as bags or small packages.

*Manual transmission only.

**Automatic transmission only.

†Coupe only.

6 CHOOSE YOUR JAGUAR GEAR ACCESSORIES

 Configure your vehicle at jaguarusa.com



Silver Weave Carbon Fiber Side Power Vents*
T2R25198 - Left Side T2R25197 - Right Side

High-grade Silver Weave Carbon Fiber side power vents provide a performance-inspired styling enhancement. Featuring a 2x2 twill weave with an eye-catching aluminum thread and a High Gloss lacquered finish.



Silver Weave Carbon Fiber Hood Louvers
T2R25193 - Left Side RWD T2R25191 - Right Side RWD
T2R25194 - Left Side AWD T2R25192 - Right Side AWD

High-grade Silver Weave Carbon Fiber hood louvers featuring a 2x2 twill weave with aluminum thread and a High Gloss lacquered finish. Provides an eye-catching, performance-inspired styling enhancement coupled with the weight-saving benefits associated with carbon fiber.



Silver Weave Carbon Fiber Mirror Covers
T2R25196 - Left Side T2R25195 - Right Side

High-grade Silver Weave Carbon Fiber mirror covers provide a performance-inspired styling enhancement. Featuring a 2x2 twill weave with an eye-catching aluminum thread and a High Gloss lacquered finish.



Silver Weave Carbon Fiber Roll Hoops**
T2R23379 - Left Side T2R23378 - Right Side

High-grade Silver Weave Carbon Fiber roll hoops featuring a 2x2 twill weave with aluminum thread and a High Gloss lacquered finish. Provides an eye-catching, performance-inspired styling enhancement coupled with the weight-saving benefits associated with carbon fiber.



Wind Deflector†
T2R11321

Simple to fit and remove, the wind deflector reduces air draught and turbulence in the passenger compartment, even at high speeds. Supplied with a Jaguar branded storage bag.



Gloss Black Side Power Vents*
T2R5996 - Left Side T2R5995 - Right Side

Jaguar branded Gloss Black side power vents provide a dynamic exterior styling enhancement.



Chrome Hood Louvers**
T2R5277LML - Left Side T2R5276LML - Right Side

Bright finish accents highlight the F-TYPE exterior styling cues.



Chrome Mirror Covers
T2R5399 - Left Side T2R5400 - Right Side

Chrome mirror covers accentuate the stylish design of the exterior mirrors.



Chrome Roll Hoops**
T2R5402 - Left Side T2R5401 - Right Side

Bright finish accents highlight the F-TYPE exterior styling cues.



All-Weather Car Cover
T2R4364

All-weather tailored cover for the F-TYPE with the Jaguar logo. Protect your F-TYPE from the elements, including rain, frost and dust. Quick and easy to fit.



Carbon Fiber Mirror Covers
T2R5390 - Left side T2R5389 - Right side

High grade Carbon Fiber mirror covers provide a performance-inspired styling upgrade.



Gloss Black Grille
T2R13838 - Without Parking Aids
T2R13839 - With Parking Aids

Provides a High Gloss Black finish to the grille surround and bumper beam accentuating the dramatic appearance of the F-TYPE.

*N/A with F-TYPE SVR.

**Available for F-TYPE Convertible only.

*Standard on F-TYPE R and F-TYPE SVR. Also available as a line fit option.

**Not applicable for AWD models.

TECHNICAL SPECIFICATIONS

 Configure your vehicle at jaguarusa.com

ENGINES		F-TYPE JAGUAR 2.0 LITER i4 296 TURBOCHARGED GAS	F-TYPE JAGUAR 3.0 LITER V6 340 SUPERCHARGED GAS
Cylinders/Valves per Cylinder		4/4	6/4
Bore/Stroke	inches	3.27/3.64	3.33/3.50
Capacity	cc	1,997	2,995
Maximum power	HP	296	340
@rev/min		5,500	6,500
Maximum torque	lb-ft	295	332
@rev/min		1,500 - 4,500	3,500 - 5,000
Compression	ratio:1	9.5	10.5
Tank capacity (usable)	US gallons	16.6	18.5

PERFORMANCE ^{1,3}		COUPE AUTO	CONVERTIBLE AUTO	COUPE MANUAL	COUPE AUTO	CONVERTIBLE MANUAL	CONVERTIBLE AUTO
0-60 mph	seconds	5.4	5.4	5.5	5.1	5.5	5.1
Top speed	mph	155	155	161	161	161	161

DIMENSIONS		COUPE	CONVERTIBLE	COUPE	CONVERTIBLE
Overall length	in	176.5	176.5	176.5	176.5
Overall width (inc. mirrors)	in	80.4	80.4	80.4	80.4
Overall width (excl. mirrors)	in	75.7	75.7	75.7	75.7
Overall height	in	51.6	51.5	51.6	51.5
Wheelbase	in	103.2	103.2	103.2	103.2
Front track	in	62.9†	62.9†	62.9†	62.9†
Rear track	in	64.9‡	64.9‡	64.9‡	64.9‡
Ground clearance	in	4.0	4.0	4.0	4.0
Turning circle diameter (curb to curb)	ft.	35.1	35.1	35.1	35.1
Convertible trunk volume	cu.ft	—	7.3	—	7.3
Coupe trunk volume with cargo space cover	cu.ft	10.9	—	10.9	—
Coupe trunk volume without cargo space cover	cu.ft	14.4	—	14.4	—

WEIGHT ²		COUPE AUTO	CONVERTIBLE AUTO	COUPE MANUAL	COUPE AUTO	CONVERTIBLE MANUAL	CONVERTIBLE AUTO
Weight from	lbs	3,360	3,405	3,455	3,477	3,499	3,521
Gross vehicle weight	lbs	4,245	4,245	4,519	4,519	4,519	4,519

*Please see page 116 for further information.

**F-TYPE R-Dynamic only.

†3,494 lbs on 20" wheels.

‡3,587 lbs on 20" wheels.

DIMENSIONS

Dimensions shown are based upon F-TYPE R, Coupe and Convertible. For details of all derivatives please refer to the Technical Specifications on page 108 and 109.

Overall Width (inc mirrors) 80.4 inches

Overall Width (excl mirrors) 75.7 inches

Trunk Volume 14.4 cu.ft (Coupe) 7.3 cu.ft (Convertible)



Turning Circle
Curb-to-Curb
35.1ft (RWD)
37.1ft (AWD)



Figures shown are for F-TYPE R. See pages 108-109 for full details on Technical Specifications.
VEHICLE SHOWN F-TYPE R IN YULONG WHITE WITH OPTIONAL EQUIPMENT

JAGUAR EXPERIENCE

There's no better way to get to know Jaguar than by taking a drive. The Jaguar Experience offers a range of unique opportunities to really find out what it feels like to get the most out of a Jaguar vehicle. Our track experiences allow you to push yourself and vehicles from the incredible Jaguar range to the limit. Jaguar Experience also offers the opportunity to see a Jaguar brought to life during a tour of one of our UK manufacturing facilities.

Find out more by visiting jaguarusa.com



BEHIND THE SCENES

Our factory tours give you the unique opportunity to experience the whole process of how our cars are brought to life - from the molding of sheet metal to those intricate final touches. At our state-of-the-art production facilities, you'll get to see how skilled technicians and sophisticated machines work seamlessly together to perfect some of the most breathtaking Jaguar vehicles.

Find out more at jaguarusa.com



DRIVING EXPERIENCES

The opportunity to drive the latest Jaguar vehicles at their limits, or relive iconic Jaguar history, is rare. Jaguar Driving Experiences offer unique driving adventures you will never forget. Imagine yourself behind the wheel of our highest performing Jaguar models, on a private track, with a Jaguar Experience Instructor at your side. This is the Jaguar Performance Driving Academy.

Find out more at jaguarusa.com



ICONIC EXPERIENCES

Take your driving to the next level with the Jaguar Land Rover Ice Drive Experience. From 2017, we are offering an adventure in Arjeplog, Sweden, that will test and develop your performance driving skills in extreme conditions. It's a rare chance for owners and enthusiasts to tackle some of the harshest and most challenging tracks on earth, under the skilled guidance of our experts. Our driving instructors are of the highest-caliber and will be with you every step of the way - ready to impart years of driving wisdom. You will dance on ice, glide around some of the most awe-inspiring corners imaginable and realize the true exhilarating potential of Jaguar and Land Rover.

If you'd like to be part of the next adventure, find out more by visiting jaguarusa.com

THE WORLD OF JAGUAR

Choose an F-TYPE and you're joining the exciting World of Jaguar. It makes owning and driving carefree and easy, as well as providing a range of exclusive services and lifestyle products.



JAGUAR ELITECARE

Enjoy your Jaguar with peace of mind. The F-TYPE is backed by Jaguar EliteCare*⁷, our exceptional 5 year / 60,000 mile coverage program including New Vehicle Limited Warranty, Complimentary Scheduled Maintenance, Roadside Assistance and Jaguar InControl® Remote & Protect™.

GENUINE PARTS

Jaguar Genuine Parts are designed, tested and manufactured to our uncompromising standards for quality, fit and durability. Each part is engineered specifically for your F-TYPE to contribute to optimum performance and to help maximize lifespan.



JAGUAR FINANCIAL SERVICES

Effortless performance and style come as standard with every Jaguar vehicle. Jaguar Financial Services makes buying one just as simple and rewarding. New or used, for personal or business use, we have an option that puts you in complete control. Please speak to your local Jaguar Retailer to find out more.

*Please see page 116 for further information.



ROADSIDE ASSISTANCE

Jaguar Optimized Assistance provides assistance in motoring emergencies, from immobilization due to breakdown or accident to minor problems such as punctures. You can rely on our roadside assistance, whatever the situation, anywhere in North America during the vehicles warranty period.



FLEET & BUSINESS

Jaguar is dedicated to being the premium manufacturer of choice for fleets and businesses by providing a highly attractive vehicle range and exemplary customer service. Jaguar vehicles are dynamic and distinctive, and help companies express the unique character and personality of their business. We are committed to providing totally customer-focused aftersales services, which keeps every Jaguar vehicle on the move and in top condition, ensuring that they perform to the highest standard and in the most cost-efficient way for businesses. Visit jaguarusa.com for more information.



JAGUAR MAGAZINE

This is our own vibrant, cosmopolitan and contemporary magazine. Produced by a team of enthusiastic designers and feature writers, it goes behind the scenes at Jaguar as well as providing insight into the world of luxury, design, style and travel.

JAGUAR COLLECTION

The latest Jaguar Collection has been crafted with the same design execution and attention to detail that goes into all of our vehicles. This is evident in our clothing range, premium leather items and luxury travel goods. To celebrate Jaguar's heritage we also have a collection that honors past achievements and features race inspired gift items and apparel. Visit shop.jaguarusa.com to browse the Jaguar Collection.

GLOSSARY

A

ABS SYSTEM

This anti-lock braking system prevents wheel lock up under heavy braking to maintain vehicle control.

ACTIVE SPORTS EXHAUST

This system features active valves that, when open, allow the exhaust gases to exit via a more direct route producing a richer, more exhilarating noise. The system also allows the driver to use a button on the center console (if optioned) to manually activate the valves.

AMBIENT INTERIOR MOOD LIGHTING

Ambient Interior Mood Lighting highlights many of the cabin's key features and design details in a relaxing soft Phosphor Blue.

AUDYSSEY MULTEQ AUDIO EQUALIZATION

Audyssey MultEQ Audio Equalization digitally corrects any imperfections created by the cabin environment to deliver accurate, enveloping, and distortion-free sound for all seating positions.

C

CABIN CORRECTION ALGORITHM

Meridian's Cabin Correction Algorithm intelligently and discreetly optimizes the audio system to the precise acoustics of the vehicle cabin, preserving the natural rhythm of the performance.

CAE DEVELOPMENT PROCESS

Computer-Aided Engineering (CAE) is the usage of computer models and software to aid engineering analysis.

COMBUSTION CHAMBER

A combustion chamber is the part of an engine where the fuel and air mixture is burned.

D

DIE-CAST ALUMINUM BLOCKS

Die-casting is a metal casting process used to form the aluminum blocks for the F-TYPE engines. It involves forcing molten metal under high pressure into a mould. This allows for excellent dimensional accuracy and the casting of thinner walls.

DSP AMPLIFIER

Meridian's Digital Signal Processing (DSP) technology analyzes a range of variables that may impact audio quality, then processes them using sophisticated algorithms and adapts the system's output accordingly. This enables a level of powerful, authentic performance impossible with a conventional sound system.

DUAL INDEPENDENT VARIABLE CAMSHAFT TIMING

Dual Independent Variable Camshaft Timing is a feature whereby the engine can adjust the timing of both the intake and exhaust valves independently. This allows for improved power and torque, particularly at lower engine revs, as well as improved fuel economy and reduced emissions.

DAMPERS/DAMPING

Dampers absorb forces acting on the suspension for greater ride comfort and control. Dampers are also known as shock absorbers.

F

FORGED ALUMINUM DOUBLE WISHBONE SUSPENSION

The F-TYPE front and rear double wishbone suspension is an independent suspension design using two wishbone-shaped arms to place the wheel. Double wishbone designs deliver precise handling and steering response.

I

INCONEL®

Inconel is a family of austenite nickel-chromium-based superalloys. Inconel alloys are oxidation and corrosion resistant materials well suited for service in extreme environments subjected to pressure and heat.

INTELLIGENT STOP/START

Stop/Start is a technology that stops the engine when it is not needed, improving the fuel economy and reducing the car's CO₂ emissions. The engine will restart immediately as soon as the driver's foot comes off the brake pedal. The engine will be operating at full capacity before the driver's foot has touched the accelerator pedal.

M

MANUAL MODE

Manual Mode is a mode available on automatic transmissions that allows you to manually upshift and downshift.

MERIDIAN TRIFIELD™ TECHNOLOGY

Meridian's exclusive Trifield™ technology, delivers a consistent, concert-like experience, optimized for all seating positions.

MONOBLOC CALIPERS

Monobloc calipers are forged from one piece of metal. This makes them more resistant to flex under load, so they waste less energy and deliver consistent braking feel.

MULTI-PLATE CLUTCH

A Multi-plate clutch uses several friction discs to transmit power from the engine to the transmission. This decreases drag and increases the amount of torque that is transmitted while minimizing the amount of force needed to operate the clutch, enabling faster and smoother shifting.

S

SHORT-THROW GEARSHIFT

A short-throw gearshift has a reduced length to enable swifter gear changes.

SUPERCHARGED GAS

A gas engine with a supercharger. A supercharger is a forced induction device mechanically driven by the engine. It offers higher power outputs and immediate, linear response at all engine speeds.

*DISCLAIMERS

1 - Driving while distracted can result in loss of vehicle control. Do not operate, adjust or view the navigation or multimedia systems under conditions that will affect your safety or the safety of others. Only use mobile phones and other devices, even with voice commands, when it is safe to do so.

2 - These features are not a substitute for driving safely with due care and attention and will not function under all circumstances, speeds, weather and road conditions, etc. Driver should not assume that these features will correct errors of judgment in driving. Please consult the owner's manual or your local authorized Jaguar Retailer for more details.

3 - Always follow local speed limits.

4 - This feature is not a substitute for safe and attentive driving, nor can it overcome all extreme circumstances. Please consult the owner's manual or your local authorized Jaguar Retailer for more details.

5 - Do not use Land Rover InControl® features under conditions that will affect your safety or the safety of others. Driving while distracted can result in loss of vehicle control.

6 - A 3-month trial subscription to the SiriusXM All Access package is included with the vehicle, which gives you access to 175+ channels of premium programming. Plus you can stream SiriusXM on your computer, smartphone or tablet - it's included in your trial. If you decide to continue service after your trial, the subscription plan you choose will automatically renew thereafter and you will be charged according to your chosen payment method at then-current rates. Fees and taxes apply. To cancel you must call SiriusXM at 1-866-635-2349. See the SiriusXM Customer Agreement for complete terms at siriusxm.com. All fees and programming are subject to change. SiriusXM Satellite Radio is not available in Alaska, Hawaii, or Puerto Rico.

7 - For complete details regarding Jaguar EliteCare coverage, visit JAGUARUSA.COM, call 1.800.4.JAGUAR or visit your local Jaguar Retailer. Servicing your vehicle at the specified interval is critical to maintaining its long-term durability. Failure to perform scheduled maintenance within 1000 miles of the recommended interval may void the Warranty under certain circumstances.

8 - Please remember that the safety belts in a vehicle constitute the primary protection system for driver and passengers in collisions. Airbags are not designed to deploy in all collisions. The airbag Supplemental Restraint System (SRS) is a supplement to the safety belts and is designed to work as a system with the safety belts. Although airbags provide additional protection, airbags without safety belts do not provide optimal protection in a crash. Always wear your safety belts. Children younger than 13 years old should always be properly restrained in a back seat, away from airbags. Never place an infant seat in the front seat.



IMPORTANT NOTICE

Jaguar Land Rover Limited is constantly seeking ways to improve the specification, design and production of its vehicles and alterations take place continually. While every effort is made to produce up-to-date literature, this brochure should not be regarded as an infallible guide to current specifications, nor does it constitute an offer for the sale of any particular vehicle. Distributors and Retailers are not agents of Jaguar Land Rover Limited by any express or implied undertaking or representation. Comparisons are based on manufacturer's own data and testing prior to publication.

COLORS

Print and online colors are representative only.

ENVIRONMENTAL INNOVATION AT JAGUAR

Jaguar is committed to reducing dependency on fossil fuels, using fewer natural resources and creating less waste as part of our approach to responsible and sustainable business development, called Environmental Innovation.

Our innovative use of lightweight aluminum (featured in the F-TYPE, F-PACE, XJ, XE and XF) is helping to improve fuel consumption and lower tailpipe CO₂ emissions, as well as delivering other handling and performance benefits to these vehicles.

At the same time, our smart management of resources enables scrap aluminum reclaimed from our stamping process to be segregated and recycled to create the same quality of aluminum sheet with up to 50% recycled content. Compared to using virgin aluminum, this closed-loop recycling system also reduces CO₂ emissions during the manufacturing process.

As a whole, Jaguar Land Rover has reduced its European fleet average tailpipe emissions by 25% versus 2007 and operational CO₂ emissions per vehicle by 30.5%*. Our manufacturing facilities are all certified to ISO14001 and we have cut the amount of manufacturing waste to landfill per vehicle by 75%* and reduced our water consumption per vehicle by 34%*. (*versus 2007) As part of our journey to Carbon Neutral Manufacturing by 2020, we offset 100% of (currently unavoidable) operational CO₂ emissions by investing in projects that reduce the equivalent amount of CO₂ emissions in other ways, providing social and humanitarian benefits at the same time. For example, our award winning Lifestraw 'Carbon for Water' emissions reduction project has prevented the release of 968,000 tonnes of CO₂ (since it began in 2013) and improved the lives of 2.4 million people in Kenya.

Taking into account the company's global sales growth and increased investment in more efficient operating facilities, we are proud of the progress we have made against our 2020 Environmental Innovation targets to date. Our achievements have also been recognized externally: In 2013 the Company was recognized as the UK's Responsible Business of the Year by leading CR index, Business in the Community and in 2014 we were awarded the Queen's Award for Enterprise in Sustainable Development.

Looking forward, we have developed a 2020 vision for sustainable business growth that focuses on continued improvements in operating & tailpipe CO₂ emissions, carbon neutral manufacturing and zero waste. Jaguar Land Rover also aims to improve the lives of 12 million people by 2020 as part of its global Corporate Social Responsibility program.

Meridian is a trademark of Meridian Audio Limited.

The Bluetooth® word mark and logos are owned by the Bluetooth SIG, Inc. and any use of such marks by Jaguar Land Rover Limited is under license.

iPhone is a trademark of Apple Inc., registered in the US and other countries.

VEHICLE SHOWN FRONT COVER: F-TYPE SVR IN CALDERA RED WITH OPTIONAL EQUIPMENT
VEHICLE SHOWN BACK COVER: F-TYPE SVR IN CALDERA RED WITH OPTIONAL EQUIPMENT

Jaguar Land Rover North America, LLC
555 MacArthur Boulevard
Mahwah, NJ 07430-2327
JAGUARUSA.COM

