

Mercedes-AMG G-Class SUV



W463

Model year 2019

Preliminary and Subject to Change

AMG

DRIVING PERFORMANCE



Important note

The information presented in this guide is based on the most current information available and is intended for internal use only. Mercedes-Benz reserves the right to make changes at any time, without notice, to colors, materials, equipment, special specifications and models.

Pricing may not yet be finalized for some models or options.

Due to variances among monitors and printers the colors that appear on your screen and printouts may not be exact.

For illustrative purposes, some images may show vehicles with European Specification.

Revision History

| <i>Date</i> | <i>Changes</i> |
|-------------|---|
| 1/30/2018 | First draft of the G-Class DOG |
| 3/15/2018 | G63 AMG First draft posted |
| 3/23/2018 | Removed EM7 Rear Seat Entertainment |
| 3/26/2018 | Delayed Availability of 418 Exclusive Interior Package Plus |



Power Tilt/Sliding sunroof



Sliding sunroof

Standard

- Provides a pleasant, draft-free circulation of air in the passenger compartment
- Gives the interior of the vehicle a brighter feel due to natural light
- Internally movable headlining affords protection against the sun
- Rain closing function: open sliding sunroof automatically moves to the tilt position when rain is detected.
- Convenience closing and summer opening functions: With the vehicle parked, the sliding sunroof can be operated from outside using the electronic vehicle key
- Obstruction sensor: If the system detects an obstruction, it automatically stops the closing process
- PRE-SAFE[®] closing function: If the PRE-SAFE[®] system detects an imminent rollover, it closes the open sliding sunroof





Touchpad controller



Touchpad controller

Standard

The functions of COMAND® navigation can be controlled intuitively via the innovative touchpad, using single or multi-finger gestures (multi-touch):

- Additional full-fledged input option supplementing the COMAND® central controller, Touch Control Buttons on the steering wheel and voice control
- Recognizes single and multi-finger gestures (multi-touch), swiping movements and zoom gestures achieved by spreading the fingers or pinching them together
- Innovative handwriting recognition feature: Users are able to input letters, special characters and numbers in their normal handwriting, in any language available in the headunit
- 3 buttons located on the touchpad allow fast and direct operation of important functions
- Clear haptic feedback when using the touchpad or keys





Burmester® Surround Sound System



Burmester® Surround Sound System

Standard

- 16 speakers precisely tailored to the vehicle interior to ensure well-balanced and dynamic music reproduction
- 9-channel-DSP-amplifier with a total output power of 590W (6 x 50 W, 2 x 25 W, 2 x 120 W) for maximum sound quality with high volume reserves
- Sound optimization for the front and rear seats
- Sound preset: Surround function to generate virtual surround sound.
- Noise compensation (VNC)





Ambient lighting with 64 colors



Ambient lighting with 64 colors and 3 color zones (FR2)

Standard

- The ambient lighting in 64 colors gives the light a uniquely diverse style and showcases the interior like a work of art.
- Every display style of the widescreen cockpit is oriented towards a matching color scheme: "Glacier Blue" for Classic, "Red Moon" for Sport, "Down Blue" for Progressive
- Eight color schemes consist of two colors respectively – the display and the footwell are in the same color, and the trim level forms a contrast.
- Two further color schemes each contain five colors – these divide the vehicle into the levels "upper display and roofline", "lower display", "feature line (trim)", "center console and cup holder" and also "footwell".
- The colors are either static or slowly replace each other in Dynamic mode, as required, to produce a constant, pleasant change of color.
- All 64 lights can also be individually selected – for maximum individual illumination of the interior.
- LED brightness is variable, with five levels and four zones: widescreen cockpit, area of the front seats, rear plus complete dimming zone.



Headlamps



MULTIBEAM LED – trend-setting lighting technology (L57)

More safety at night and an unmistakable, striking look come courtesy of the LED High Performance headlamps. LED technology illuminates the road ahead better than conventional headlamps – and it consumes less energy and boasts a significantly longer service life. The LED light units accentuate the distinctive front end design of the G-Class yet nevertheless retain the unmistakable character.

The LED High Performance headlamps at a glance:

- Excellent illumination of the carriageway
- Distinctive look by day and night
- Color spectrum close to natural daylight
- Low energy consumption

Active Brake Assist



Active Brake Assist

Standard on all models

- Radar-based driving assistance system that can help prevent accidents with vehicles ahead and with crossing pedestrians or mitigate the consequences of accidents
- Combination of proximity warning, collision warning, on-demand braking assistance and autonomous braking function
- Additional audible warning if the distance diminishes rapidly
- If the driver initiates emergency braking – if necessary – increase in braking pressure by the on-demand braking assistance
- Initiation of autonomous braking if the driver fails to react
- Visual and audible warning plus almost simultaneous emergency braking if an impending collision with a **crossing pedestrian** is detected

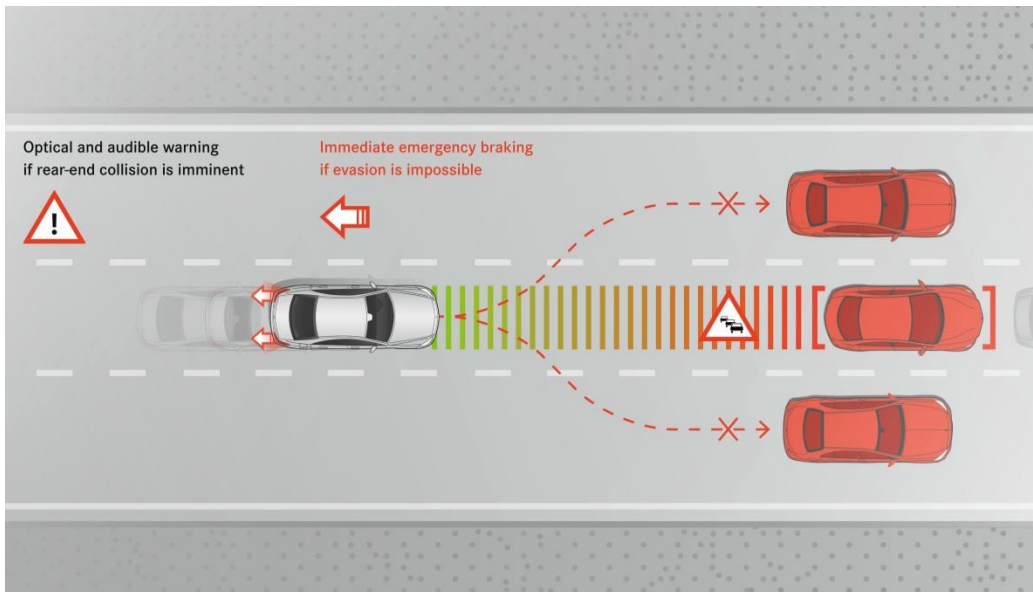

AMG G 63



Models



Interior Trims



What's new



Option Packages



Standard Equipment



Stand-Alone Options



Exterior Paint Colors



Options in Detail



Wheels



Build Recommendations



Interior Upholstery



Specifications



G63 (463.277)

- MSRP \$TBD
- Handcrafted AMG 4.0L V8 Biturbo engine
- 577 hp
- 627 lb-ft
- 4.4 sec (0-60 mph)
- Launch date: 10/2018

Handcrafted AMG 4.0L V8 biturbo engine (M177 E40DEH LA AMG)



Handcrafted AMG 4.0L V8 Biturbo engine (M177 E40DEH LA AMG) Standard

Aluminum crankcase featuring a racing inspired closed-deck design

- The area around the cylinders' coolant enclosure is closed off at the top and is only perforated by cooling channels
- This makes the engine block more rigid and able to withstand greater loads

Forged, lightweight aluminum pistons – high performance and low weight

Two Twin-scroll turbochargers with separate exhaust channels

- Positioned between the cylinder heads for faster response
- Inspired by Formula 1
- Keeps engine compact, improves turbo response and lowers emissions
- Separate exhaust channels prevent turbos from having a negative impact on each other during load/directional changes, and enables faster spooling/buildup of turbo pressure

Dynamic Engine Mounts – Adjust to DYNAMIC SELECT mode and driving conditions

- “Soft Mounts” for Comfort – Reduces engine noise and vibration
- “Hard Mounts” for Sport – Increases steering precision

Variably Adjustable Inlet and Outlet Valves

- Filled with sodium
- Light weight

AMG SPEEDSHIFT TCT 9-Speed Transmission

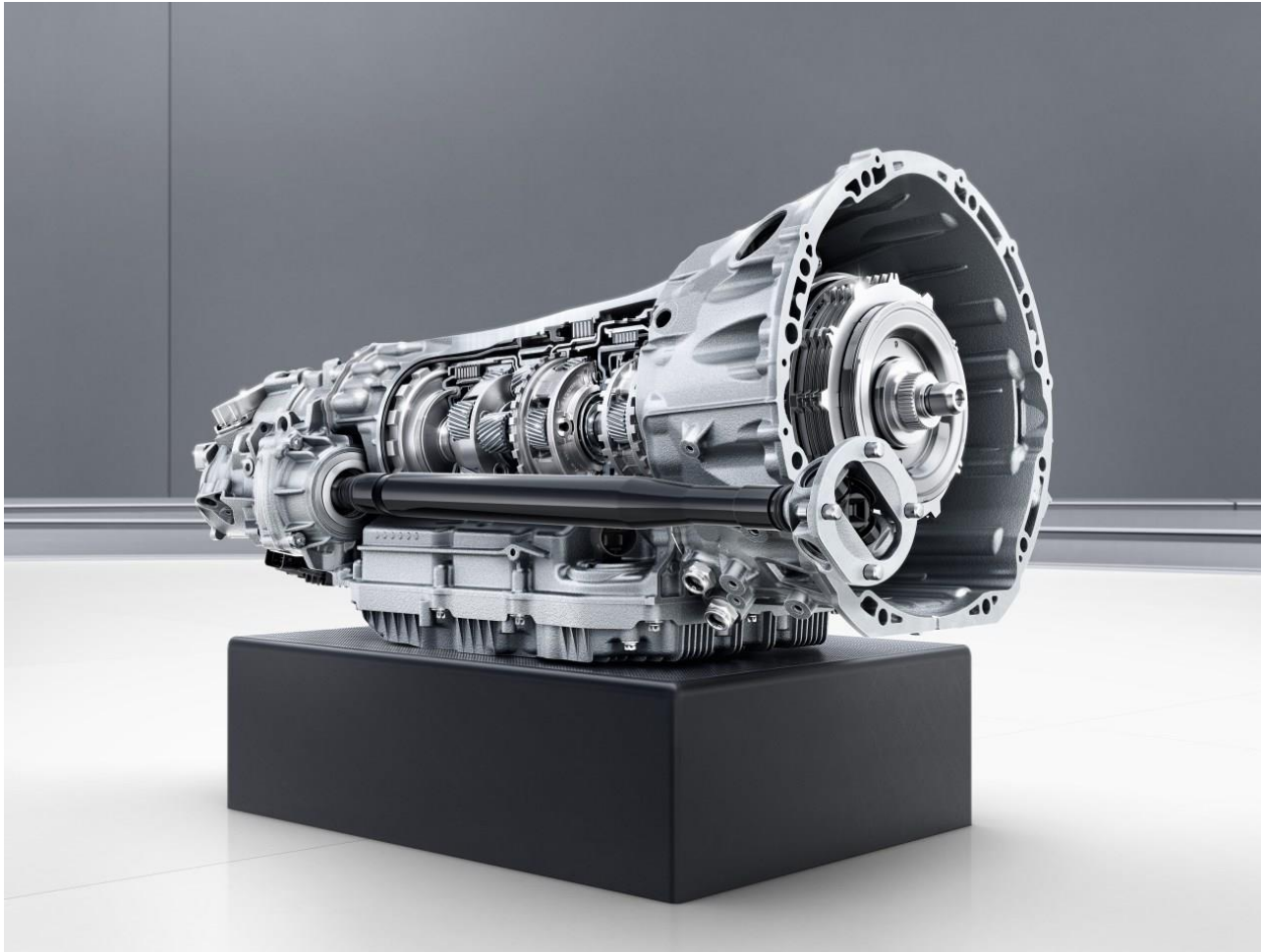

AMG SPEEDSHIFT TCT 9-Speed Transmission

Standard

AMG SPEEDSHIFT 9G-TRONIC – from extremely sporty to efficient and comfortable

With 9 gears and double-declutching function, this transmission allows extremely dynamic acceleration and ultra-short shift times as well as a fuel-saving driving style. The systematic further development of hardware and software has made it possible to further optimize the reaction times. This means that the driver's shift commands can be carried out faster than ever before. Gear changes are performed with no interruption in tractive power. Ultra-fast, responsive multiple downshifts are another forte of the AMG SPEEDSHIFT 9G-TRONIC. The driver can change via kickdown directly from 9th into 6th or from 5th into 2nd gear, for example.

The AMG SPEEDSHIFT 9G-TRONIC at a glance:

- Drive program-specific drive settings (according to selected AMG DYNAMIC SELECT drive program) with different characteristic curves for accelerator pedal and shifting:
 - "C" (Comfort): Particularly efficient and comfortable
 - "S" (Sport): sporty gearshift characteristics with shorter shift times
 - "S" (Sport+): even sportier gearshift characteristics with the shortest shift times
- Manual mode "M", selectable using M button: Transmission responds even faster to manual shift commands, the driver's shift commands are carried out at unprecedented speed, drive train reacts immediately and precisely
- Momentary M mode: Change to "M" by actuating the shift paddles
- Partial ignition interruption during upshifts for an emotive sound
- Further optimised reaction times for fastest-possible execution of the driver's shift commands thanks to consistent further development of hardware and software
- ECO start/stop function and gliding function in drive program "C"
- Automatic double-declutching function when downshifting

Exterior - 2018 G63 (W463) vs. 2019 G63 (W463)



*European model shown

Interior - 2018 G63 (W463) vs. 2019 G63 (W463)



AMG Edition 1



AMG Edition 1:

- Dimmed flash- and backlights and headlamps
- AMG carbon-fiber trim in red pepper (VA6)
- Exterior mirrors painted in obsidian black
- AMG Sport stripes in grey
- Dark-tinted glass for rear side windows and rear window (W72)
- Bulbar painted black (country-specific)
- Spare wheel ring painted in obsidian black
- Trims in the bumper front and rear in obsidian black
- Underride guard painted in obsidian black
- 22" wheels matte black (RG4), rim flange painted in red pepper
- Available colors:
 - *designo* Night Black magno (056)



Performance & Handling

- AMG SPEEDSHIFT TCT 9G-Tronic Automatic Transmission
- Handcrafted AMG 4.0L V8 Biturbo Engine
- AMG DYNAMIC SELECT with 5 Drive Modes & 3 Additional Offroad Modes
- Permanent All-Wheel Drive (40:60 Distribution)
- Independent Suspension for the Front Axle
- AMG High-Performance Braking System
- AMG Performance Exhaust with switchable flap system
- 2-Speed Transfer Case (Low Range)
- 3 Independent Differential Locks
- Electric steering rack

Comfort & Convenience

- AMG Ride Control sports suspension with adjustable damping
- Newly designed Sunroof
- 3 climate zone rear
- COMAND® Navigation incl. touchpad 12.3" central display
- AMG Performance Steering Wheel in Nappa Leather
- KEYLESS GO start function
- Burmester® Surround Sound System
- Parking Assist PARKTRONIC
- Flat-Folding 2nd Row Seat
- Rain-Sensing wipers (front and rear)
- Steering wheel with touch control buttons
- Storage (Double Cupholder front; Bottle holder 4x, trunk)
- 64-color Ambient Lighting

Safety & Security

- Advanced Airbag Protection System
- Anti-Theft Protection Package
- Active Distance Assist DISTRONIC®
- Blind Spot Assist
- Top tether anchors (all rear seats)
- Active Brake Assist
- Traffic Sign Assist
- eCall Emergency System
- Active Lane Keeping Assist
- Additional Airbags (2x A-pillar, Kneebag)
- ATTENTION ASSIST®
- Electronic Stability Program (ESP®) w/ trailer stabilization
- Rearview Camera
- Multibeam LED high performance headlamps
- PRE-SAFE®
- Full LED Headlamps w/ Adaptive Highbeam Assist

Non-metallic Paints

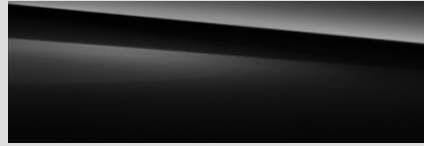

040
Black



149
Polar white

Metallic Paints

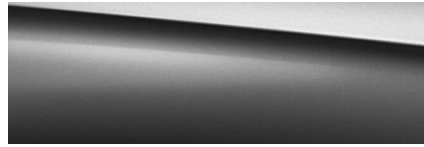

183
Magnetite black

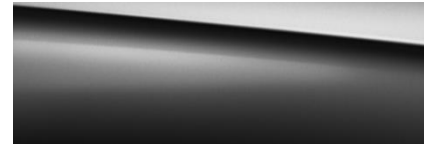

197
Obsidian black



989
Emerald green

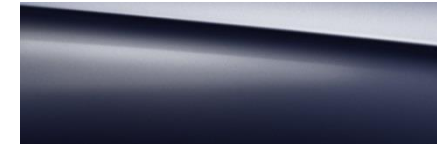

890
Lunar blue



660
Rubellite red

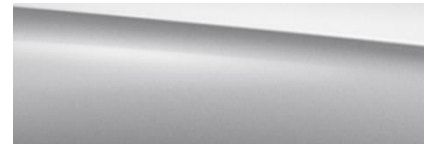

775
Iridium silver

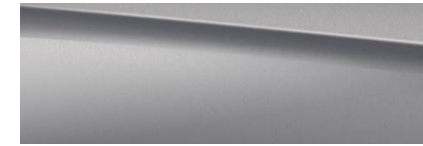

859
Mojave silver

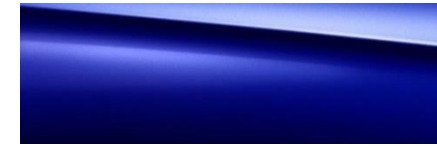

896
Brilliant blue



992
Selenite grey

designo Manufaktur Paints



464
designo desert sand

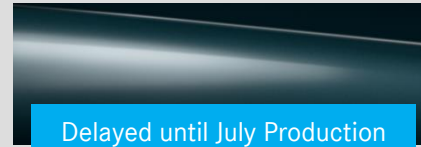

026
designo sea blue

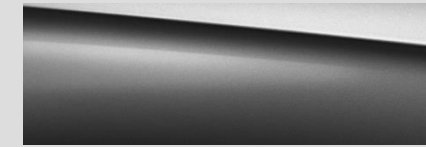

041
designo graphite



046
designo platinum black

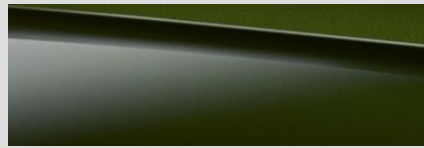

255
designo olive



996
designo cardinal red



032
designo mystic blue



799
designo diamond white

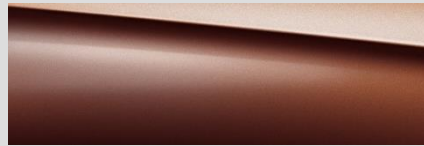

052
designo mystic brown

designo Manufaktur Magno Paints



051
designo platinum magno



056
designo night black magno



271
designo dakota brown magno

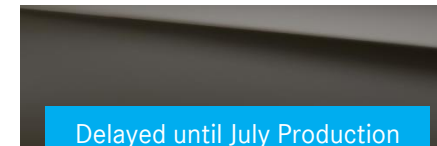

671
designo yellow olive magno



RG1
20" AMG 10-Spoke Wheels
w/ Grey Accents
Standard, Option price \$0



RG2
21" AMG Twin 5-Spoke Wheels
w/ Grey Accents
Option price: **\$TBD**



RG3
21" AMG Twin 5-Spoke Wheels,
Black
Option price: **\$TBD**



RG4
22" AMG Cross-Spoke Forged
Wheels, Matte Black
Option price: **\$TBD**



RG5
22" AMG Cross-Spoke
Forged Wheels
Option price: **\$TBD**

| <i>Code</i> | <i>Wheel Size</i> | <i>Description</i> | <i>Wheel Dimensions</i> | <i>Mobility</i> | <i>Availability</i> | <i>MSRP</i> |
|-------------|-------------------|--------------------------------|---|-----------------|---|-------------|
| RG1 | 20" | AMG 10-Spoke Wheels | 275/50 R20 on 9.5 J x 20 ET 35 (Front) 275/50 R20 on 9.5 J x 20 ET 35 (Rear) | | G63, standard | Standard |
| RG2 | 21" | AMG Twin 5-Spoke Wheels | 285/45 R21 on 10 J x 21 ET 33 (Front) 285/45 R21 on 10 J x 21 ET 33 (Rear) | | G63, optional, n/a with 521 AMG Night Package | |
| RG3 | 21" | AMG Twin 5-Spoke Wheels, Black | 285/45 R21 on 10 J x 21 ET 33 (Front) 285/45 R21 on 10 J x 21 ET 33 (Rear) | | G63, standard with 521 AMG Night Package | |
| RG4 | 22" | AMG Cross-Spoke Wheels, Black | 295/40 R22 on 10 J x 22 ET 36 (Front) 295/40 R22 on 10 J x 22 ET 36 (Rear) | | G63, optional with 521 AMG Night Package | |
| RG5 | 22" | AMG Cross-Spoke Wheels | 295/40 R22 on 10 J x 22 ET 36 (Front) 295/40 R22 on 10 J x 22 ET 36 (Rear) | | G63, optional, n/a with 521 AMG Night Package | |

Interior Upholstery – Nappa Leather



501
Black
Standard



524
Saddle Brown / Black
Option price: \$0
not available wit VA4 trim



525
Tartufo / Black
Option price: \$0



535
Macchiato Beige / Black
Option price: \$0



582
Yacht Blue / Black
Option price: \$0



583
Platinum White / Black



587

Classic Red / Black

Option price: \$0

Interior Upholstery – Exclusive Nappa Leather

Delayed through October Production



DRIVING PERFORMANCE



801

Black

Option price: \$TBD



804

Espresso Brown / Black

Option price: \$TBD



805

Macchiato Beige / Black

Option price: \$TBD

only i.c.w. VL9 steering wheel



807

Exclusive Red / Black

Option price: \$TBD

Requires 418 Exclusive Interior Package Plus***



VA2

Natural Grain Walnut Wood
Option price \$0



VA3

Brown Ash Wood
Option price: \$0



VA4

Light Brown Zen Wood
Option price: \$0
not available with 524 upholstery

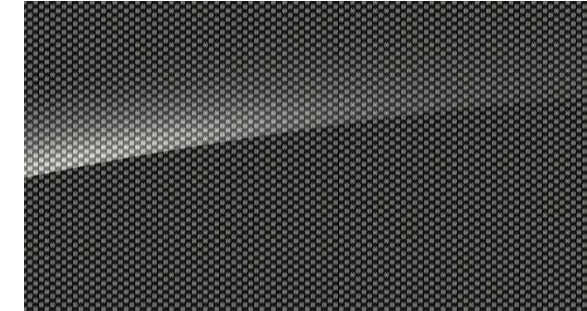

VA5

Metal Weave
Option price: \$0

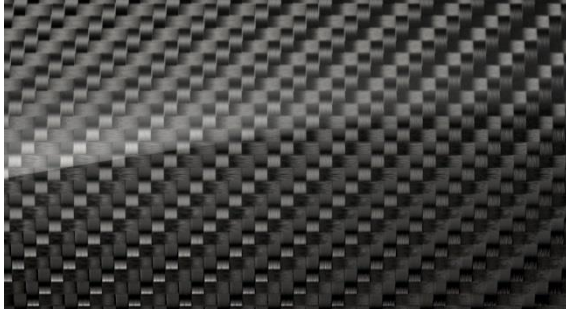

ZG6

AMG Carbon Fiber
Option price: \$TBD



VA1

designo Black Flamed Open-Pore Ash
Wood
Option price: \$TBD



ZG2

designo Black Piano Lacquer
Option Price: \$0

Interior Trims – Center Console Trim



VA2
Natural Grain Walnut Wood



VA3
Brown Ash Wood



VA4
Light Brown Zen Wood



VA5
Metal Weave



ZG6
AMG Carbon Fiber



VA1
designo Black Flamed Open-Pore Ash Wood



ZG2
designo Black Piano Lacquer

| Code | Packages | MSRP |
|------|---|--------|
| PA9 | Seat Comfort Package (listed as stand alone option PA9) <ul style="list-style-type: none"> ▪ 432 Multi-contour Seat with Energizing Massage ▪ 432 Driving Dynamic Function ▪ 902 Rapid Heating Seats ▪ 401 Ventilated Seats | \$ tbd |
| 418 | Exclusive Interior Package Plus (only i.c.w. 8xx Series Leather) Delayed through October Production <ul style="list-style-type: none"> ▪ F75 Frameless Rearview Mirror ▪ FH2 <i>designo</i> DINAMICA Headliner ▪ SR2 Exclusive Interior Package Plus ▪ JC8 Nappa Leather Dashboard ▪ PA9 Seat Comfort Package (available as stand alone option PA9) ▪ S81 Diamond Stitching ▪ VP4 <i>designo</i> floor mats | \$ tbd |
| 521 | Night Package <ul style="list-style-type: none"> ▪ Exteriors Mirrors Painted in Obsidian Black, Side Strips in High Gloss Black ▪ Brush Guard and Front Grille in Black ▪ Spare Wheel Ring and Trim Bumper Elements Painted in Obsidian Black ▪ Must choose between <ul style="list-style-type: none"> ▪ RG3 - 21" AMG Twin 5-Spoke Wheels, Black ▪ RG4 - 22" AMG Cross-Spoke Forged Wheels, Matte Black <p style="color: #c00000; font-size: 0.8em;">N/A with the following paints; 040 Black, 183 Magnetite Black Metallic, and 046 <i>designo</i> Platinum Black Metallic</p> | \$ tbd |
| 996 | Parking Package <ul style="list-style-type: none"> ▪ Parking Assist PARKTRONIC with 360 Camera | \$ tbd |

| <i>Code</i> | <i>Options</i> | <i>MSRP</i> |
|-------------|---|-------------|
| B14 | AMG Carbon Fiber Engine Cover | \$ tbd |
| PA2 | All Season Floor Mats Delayed until December Production | \$ Tbd |
| L6H | AMG Performance Steering Wheel in DINAMICA/Carbon Fiber | \$ Tbd |
| L6K | AMG Performance Steering Wheel in Nappa/DINAMICA | \$ Tbd |
| L6L | AMG Performance Steering Wheel in Leather/Wood | \$ Tbd |
| LH1 | Heated Steering Wheel | \$ Tbd |
| J25 | 12.3" Widescreen Instrument Cluster | \$ Tbd |
| Z10 | AMG Top Speed Delimiter (increases top speed to 149mph) | \$ Tbd |

Steering Wheel



AMG Performance steering wheel in black Nappa Leather (VL9)

Standard

- 3-spoke design, with flattened bottom section, perforated in the grip area, with integral AMG logo.
- Integral Touch Control buttons make for excellent operating ergonomics, inputs are accompanied by acoustic feedback.
- The steering wheel shift paddles allow manual gear changes and support a sporty driving style



AMG Performance steering wheel DINAMICA /Carbon Fiber (L6H)

Optional

only i.c.w. ZG2 design black piano lacquer trim or ZG6 carbon fiber trim

- For an even better grip during sporty maneuvers, the grip area on the AMG Performance steering wheel in carbon fiber is finished in DINAMICA microfiber.
- The sporty design is completed by silver-colored aluminum shift paddles and a 12-o'clock marking.



AMG Performance Steering Wheel in Leather/Wood (L6L)

Optional

only i.c.w. ZG2 design black piano lacquer trim or ZG6 carbon fiber trim

- The combination of high-quality leather in the grip area and fine wood inserts at the top and bottom make this steering wheel a visual and tactile highlight.



AMG Performance Steering Wheel in Nappa leather /DINAMICA (L6K)

Optional

*only i.c.w. VA1 **designo** Black Flamed Open-Pore Ash Wood, ZG2 design black piano lacquer trim, VA5 metal weave trim or ZG6 carbon fiber trim*

- 3-spoke design, with flattened bottom section, perforated in the grip area, steering wheel trim in electroplated silver chrome with integral AMG logo

Brakes



- AMG Red Painted Brake Calipers (BS2)
- Standard on AMG G63 and AMG G65; n/a for G550
- The red-painted brake calipers visually accentuate the high performance of the braking system



- AMG Silver Painted Brake Calipers (BS1)
- Optional for AMG G63 and AMG G65; n/a for G550
- N/C
- The silver-painted brake calipers visually accentuate the high performance of the braking system

AMG Night Package



- Dimmed flash- and backlights as well as headlamps
- Exterior mirrors painted in obsidian black
- Dark-tinted glass for rear side windows and rear window (W72)
- Bullbar painted black (country-specific)
- Spare wheel ring painted in obsidian black

Additional at AMG:

- Trims (location points for bulbar) in the bumper front and rear in obsidian black
- Underride guard painted in obsidian black
- Protective side strip in black with AMG Logo
- Wheel choice:
 - 21" AMG Twin 5-Spoke Wheels, Black (RG3)
 - 22" AMG Cross-Spoke Wheels, Matte Black (RG4)



| | <i>AMG G 63</i> |
|---|--------------------------------|
| Engine Configuration | 4.0L V8 biturbo engine |
| Power (hp) | 577 |
| Torque (lb-ft) | 627 |
| Displacement (cc) | 3,982 |
| Acceleration 0-60 mph (sec) | 4.4 seconds |
| Fuel Economy (Cty/Hwy/Comb) | TBA |
| Top Speed (mph) | 137 / 149 (w/ drivers package) |
| Fuel Requirement (Octane) | 91 |
| # Valves per cylinder | 4 |
| Compression | 8.6:1 |
| Transmission | AMG SPEEDSHIFT TCT 9G |
| Transmission Speeds | 9 |
| Drive Configuration | All-wheel drive |
| Fuel Tank Size (gallons) | 26.4 |
| Trunk Size (cubic feet) | TBA |
| Curb Weight (lbs) | TBA |
| Vehicle Length (in.) | 191.54 |
| Vehicle Width w/ exterior mirrors (in.) | 85.71 |
| Vehicle Height (in.) | 77.48 |
| Wheelbase (in.) | 113.78 |

MY18

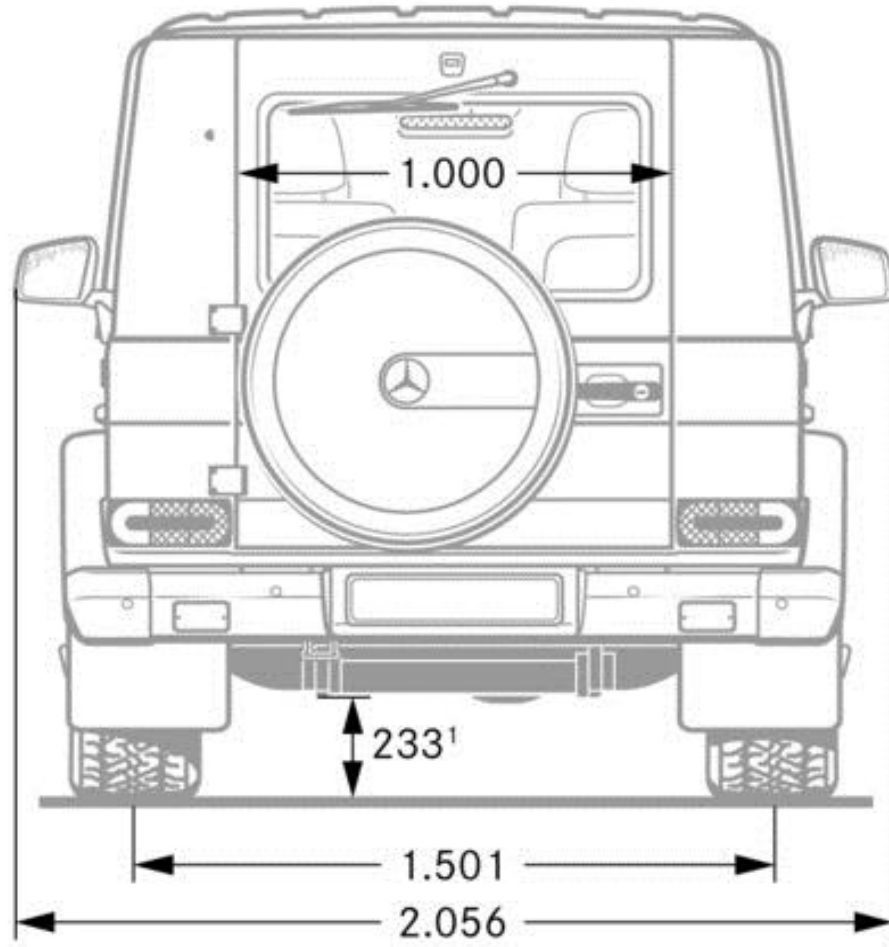

MY19

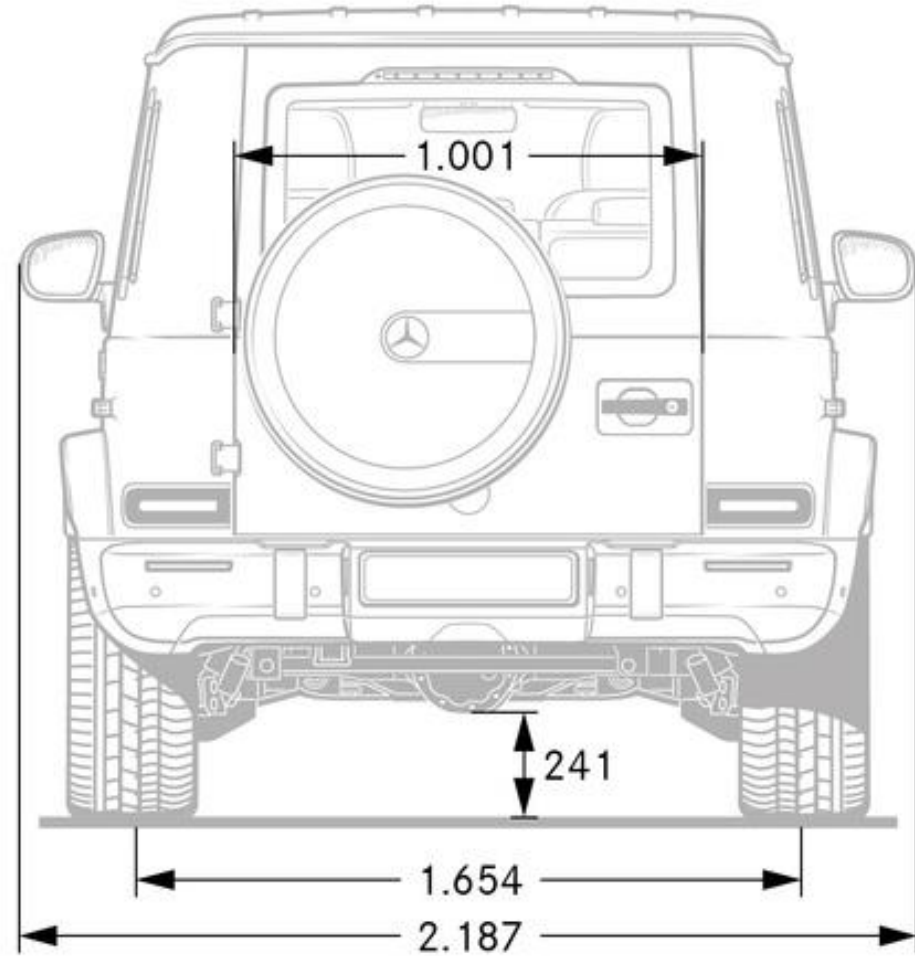

Specifications* – AMG G63

